

SIEMENS

Ingenuity for life



M.G. CABLE INDUSTRIES

Manufacturers : GI Cable Trays & All Earthing Materials

3/5, Ground Floor, Takwadi, Opp Yevale Tea Centre, Kalbadevi Road, Mumbai-400002. • Tel.: +91 22 4973 3629, 4913 7629
Cell : +91 96995 47310 • Email : mgcables29@gmail.com / info@mgcables.com • Website : www.mgcables.com

Authorised Stockist :



Our commitment is
your safe future

Electrical Installations from A to Z

Price List w.e.f. 1st February, 2021

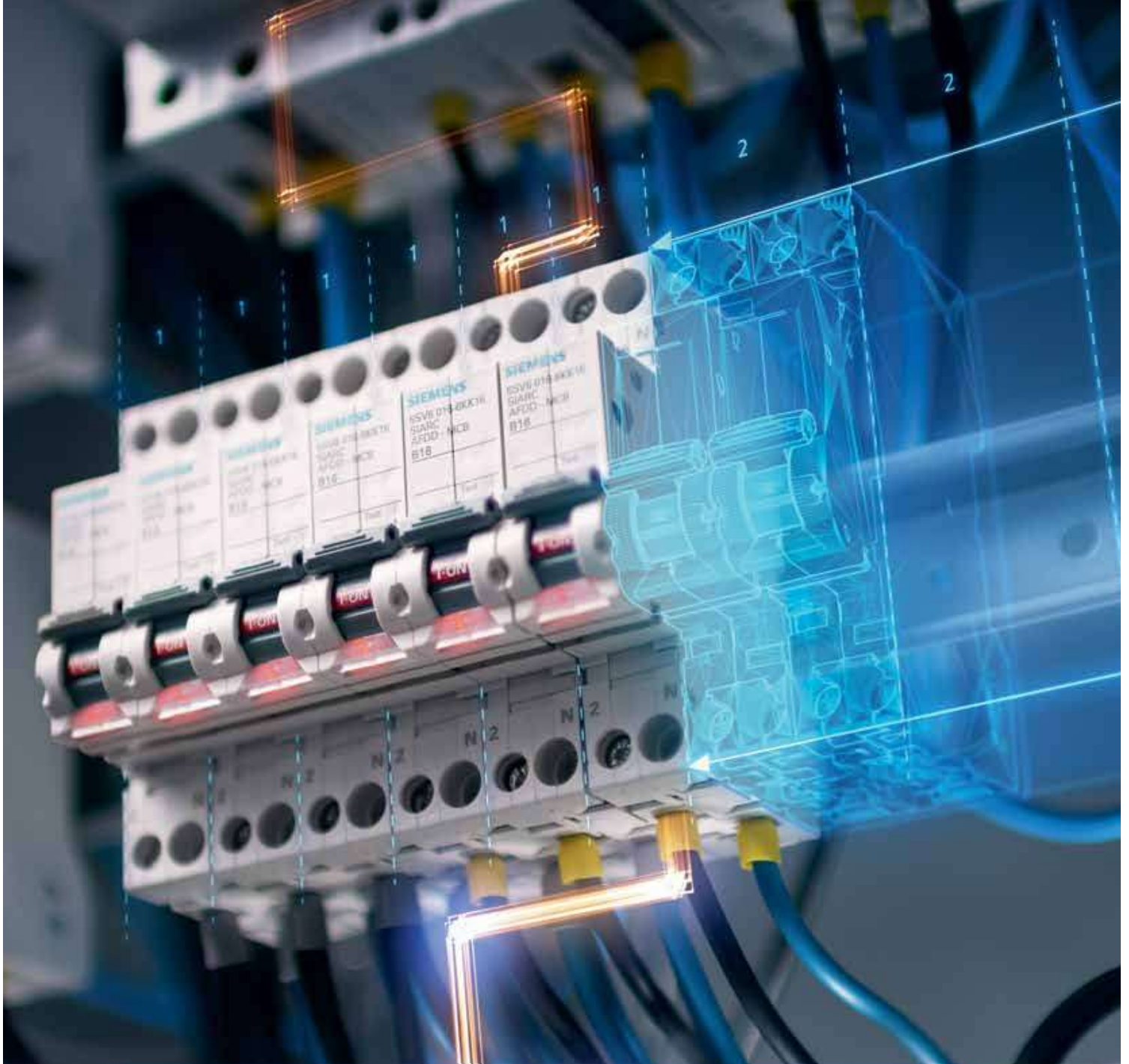

Reliable protection by preventing electrical fires

With Arc Fault Detection Device

- + Reliably detecting and shutting down hazardous arcing faults. Lower probability of electrical fires
- + Unique compact 1 module width AFDD with integrated MCB or RCBO. Easy for modification in existing installation
- + Self-test function checks the functionality of device everyday and intelligent algorithms to prevent nuisance tripping due to switching arc

Index



Sr. No.	Items	Pg. No.
1	Betagard Miniature Circuit Breakers	
	5SL6, 7.5kA with C characteristics	5
	5SL6, 7.5kA with B characteristics	6
	5SL4, 10kA with C characteristics	7
	5SL7, with C characteristics	8
	5SL7, with D characteristics	9
	5SP4, 10kA with C and D characteristics	10
2	Betagard Circuit Breakers	
	5SY4, 10kA CBs with C characteristics	10
	5SL5, 10kA DC with C characteristics	11
3	Betagard Isolators	
	5TL1 Isolators	11
4	Betagard Residual Current Circuit Breakers	
	5SV RCCB - Type AC, Type A	14
	5SM3 RCCB - Type AC, Type A	15
5	Betagard Residual Current Breaker Operators	
	5SU1 RCBO, 10kA, Type AC with C and D characteristics	16
	5SU1 RCBO, 10kA, Type A with C and D characteristics	17
6	Betagard Accessories NEW	18
7	SIRENEW	19
8	Arc Fault Detection Devices (AFDD) NEW	20-23
9	Betagard Distribution Boards	
	8GB32 SPN, TPN & Phase Segregated DBs	25-27
	8GB0 SPN & TPN DBs	28
	8GB31 - Flexi, Bus, Bus Plus, Multi, CO DBs	29
	Wire Way Boxes & Modular Device Boxes	30
	Industrial Plug & Socket DBs, Simbox WP DBs	30
	Accessories for Betagard DBs	31
10	Sentron Surge Protection Devices NEW	
	Surge Protection Devices	32-35
11	Sentron Modular Devices	
	Changeover switches, Insta contactors	37
	Twilight switch, Voltage relays, Indicators and Fuse monitors	38
	Time switches	39
12	Sentron MCCBs -3VM, RAJA+ Starters ordering info	40-41
13	Switch Disconnecter Fuses - 3KL and Fuses - 3NA/3NW ordering info	42
14	Available till stocks last	43
15	Discontinued products	44
16	5SL Miniature Circuit Breaker - K & Z Curve NEW	45
17	Multi channel current measuring system	46-47
18	Technical Information	48-49
19	Customer Care	50

Betagard 5SL MCBs – Inspiring Safety



Terminal covers for protection

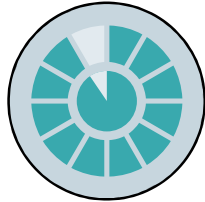

High Endurance Cycle



Ergonomic Handle for Identification



High Breaking capacity (Icn)

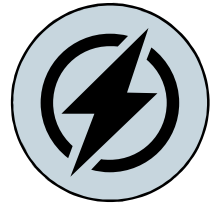

Very low watt loss



High ambient temperature

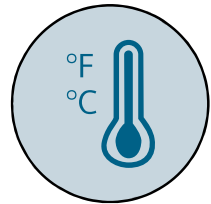

With SLR

Unique SLR (Slide Latch-Release) feature for tool free removal from DIN rail allows individual MCB to be removed from bus bar mounted assembly without disturbing other devices

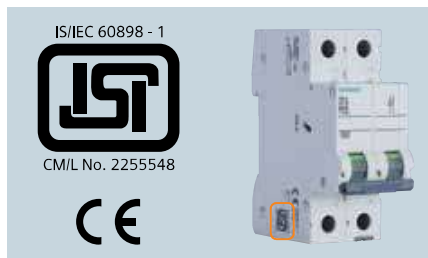

BIS approval for ISI marking as per latest IS/IEC 60898-1:2015 for assured quality and protection

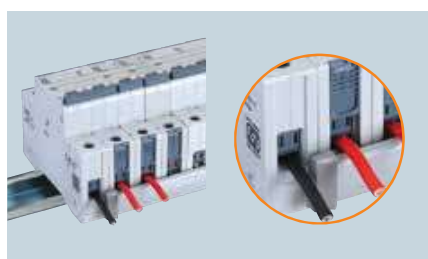





Unique termination mechanism enables firm mounting of Bus bar together with wire; and provides front access to wires for safe installation

Betagard Miniature Circuit Breakers 5SL6, with C Characteristics



- Standards: IS/IEC 60898-1:2015
- Voltage: Un 240/415V, 50...60Hz^
- With ISI marking: CM/L No. 2255548

7500A	Rated Current I _n (A)	MW#	Reference No	Unit MRP* ₹	Std. Pkg.** (Nos.)	
	1P, 240/415V AC	1	5SL61057RC	411.-	1/12	
	1		5SL61017RC	411.-	1/12	
	2		5SL61027RC	411.-	1/12	
	3		5SL61037RC	411.-	1/12	
	4		5SL61047RC	411.-	1/12	
	6		5SL61067RC	254.-	1/12	
	8		5SL61087RC	254.-	1/12	
	10		5SL61107RC	254.-	1/12	
	13		5SL61137RC	254.-	1/12	
	16		5SL61167RC	254.-	1/12	
	20		5SL61207RC	254.-	1/12	
	25		5SL61257RC	254.-	1/12	
	32		5SL61327RC	254.-	1/12	
	40		5SL61407RC	555.-	1/12	
	50		5SL61507RC	645.-	1/12	
	63		5SL61637RC	645.-	1/12	
	2P, 415V AC	2	5SL62057RC	1098.-	1/6	
	1		5SL62017RC	1098.-	1/6	
	2		5SL62027RC	1098.-	1/6	
	3		5SL62037RC	1098.-	1/6	
	4		5SL62047RC	1098.-	1/6	
	6		5SL62067RC	822.-	1/6	
	8		5SL62087RC	822.-	1/6	
	10		5SL62107RC	822.-	1/6	
	13		5SL62137RC	822.-	1/6	
	16		5SL62167RC	822.-	1/6	
	20		5SL62207RC	822.-	1/6	
	25		5SL62257RC	822.-	1/6	
	32		5SL62327RC	822.-	1/6	
	40		5SL62407RC	1133.-	1/6	
	50		5SL62507RC	1342.-	1/6	
	63		5SL62637RC	1342.-	1/6	
	3P, 415V AC	3	5SL63057RC	1542.-	1/4	
	1		5SL63017RC	1542.-	1/4	
	2		5SL63027RC	1542.-	1/4	
	4		5SL63047RC	1542.-	1/4	
	6		5SL63067RC	1224.-	1/4	
	10		5SL63107RC	1224.-	1/4	
	16		5SL63167RC	1224.-	1/4	
	20		5SL63207RC	1224.-	1/4	
	25		5SL63257RC	1224.-	1/4	
	32		5SL63327RC	1224.-	1/4	
	40		5SL63407RC	1713.-	1/4	
	50		5SL63507RC	1913.-	1/4	
	63		5SL63637RC	1913.-	1/4	
		4P, 415V AC	4	5SL64057RC	2129.-	1/3
		1		5SL64017RC	2129.-	1/3
		2		5SL64027RC	2129.-	1/3
4			5SL64047RC	2129.-	1/3	
6			5SL64067RC	1692.-	1/3	
10			5SL64107RC	1692.-	1/3	
16			5SL64167RC	1692.-	1/3	
20			5SL64207RC	1692.-	1/3	
25			5SL64257RC	1692.-	1/3	
32			5SL64327RC	1692.-	1/3	
40			5SL64407RC	2206.-	1/3	
50			5SL64507RC	2532.-	1/3	
63			5SL64637RC	2532.-	1/3	

■ Stock items

Note:

* MRP - Maximum Retail Price

1MW (Module Width) = 18mm

** Purchase MOQ for our authorised dealers is in multiples of standard packing, contact Siemens Sales Office for further details





^ Suitable for DC networks in Telecom application; 60V DC for 1P & 110V DC for 2P (contact sales office for connection diagram)

Miniature Circuit Breakers

Betagard Miniature Circuit Breakers 5SL6, with B Characteristics



- Standards: IS/IEC 60898-1:2015
- Voltage: Un 240/415V, 50...60Hz
- With ISI marking: CM/L No. 2255548

7500A	Rated Current I_n (A)	MW#	Reference No	Unit MRP* ₹	Std. Pkg.** (Nos.)			
	1P, 240/415V AC	1	<ul style="list-style-type: none"> 5SL61066RC 5SL61106RC 5SL61166RC 5SL61206RC 5SL61256RC 5SL61326RC 5SL61406RC 5SL61506RC 5SL61636RC 	248.- 248.- 248.- 248.- 248.- 248.- 553.- 621.- 621.-	1/12 1/12 1/12 1/12 1/12 1/12 1/12 1/12 1/12			
		2P, 415V AC	2	5SL62066RC 5SL62106RC 5SL62166RC 5SL62206RC 5SL62256RC 5SL62326RC 5SL62406RC 5SL62506RC 5SL62636RC	805.- 805.- 805.- 805.- 805.- 805.- 1133.- 1332.- 1332.-	1/6 1/6 1/6 1/6 1/6 1/6 1/6 1/6 1/6		
			3P, 415V AC	3	5SL63066RC 5SL63106RC 5SL63166RC 5SL63206RC 5SL63256RC 5SL63326RC 5SL63406RC 5SL63506RC 5SL63636RC	1224.- 1224.- 1224.- 1224.- 1224.- 1224.- 1690.- 1896.- 1896.-	1/4 1/4 1/4 1/4 1/4 1/4 1/4 1/4 1/4	
				4P, 415V AC	4	5SL64066RC 5SL64106RC 5SL64166RC 5SL64206RC 5SL64256RC 5SL64326RC 5SL64406RC 5SL64506RC 5SL64636RC	1683.- 1683.- 1683.- 1683.- 1683.- 1683.- 2100.- 2524.- 2524.-	1/3 1/3 1/3 1/3 1/3 1/3 1/3 1/3 1/3

■ Stock items

Note:

* MRP - Maximum Retail Price # 1MW (Module Width) = 18mm





** Purchase MOQ for our authorised dealers is in multiples of standard packing, contact Siemens Sales Office for further details



Betagard Miniature Circuit Breakers 5SL4, with C characteristics



- Standards: IS/IEC 60898-1:2015
- Voltage: Un 240/415V, 50...60Hz^
- Breaking capacity: 10kA as per IS/IEC 60898-1
- With ISI marking: CM/L No. 2255548

10000A	Rated Current I_n (A)	MW#	Reference No	Unit MRP* ₹	Std. Pkg.** (Nos.)
	1P, 240/415V AC	1	5SL41057RC	467.-	1/12
	2	5SL41027RC	467.-	1/12	
	3	5SL41037RC	467.-	1/12	
	4	5SL41047RC	467.-	1/12	
	6	5SL41067RC	303.-	1/12	
	8	5SL41087RC	303.-	1/12	
	10	5SL41107RC	303.-	1/12	
	13	5SL41137RC	303.-	1/12	
	16	5SL41167RC	303.-	1/12	
	20	5SL41207RC	303.-	1/12	
	25	5SL41257RC	303.-	1/12	
	32	5SL41327RC	303.-	1/12	
	40	5SL41407RC	660.-	1/12	
	50	5SL41507RC	660.-	1/12	
	63	5SL41637RC	660.-	1/12	
	2P, 415V AC	2	5SL42057RC	1253.-	1/6
	2	5SL42027RC	1253.-	1/6	
	3	5SL42037RC	1253.-	1/6	
	4	5SL42047RC	1253.-	1/6	
	6	5SL42067RC	898.-	1/6	
	8	5SL42087RC	898.-	1/6	
	10	5SL42107RC	898.-	1/6	
	13	5SL42137RC	898.-	1/6	
	16	5SL42167RC	898.-	1/6	
	20	5SL42207RC	898.-	1/6	
	25	5SL42257RC	898.-	1/6	
	32	5SL42327RC	898.-	1/6	
	40	5SL42407RC	1449.-	1/6	
	50	5SL42507RC	1449.-	1/6	
	63	5SL42637RC	1449.-	1/6	
	3P, 415V AC	3	5SL43057RC	2024.-	1/4
	2	5SL43027RC	2024.-	1/4	
	3	5SL43037RC	2024.-	1/4	
	4	5SL43047RC	2024.-	1/4	
	6	5SL43067RC	1508.-	1/4	
	8	5SL43087RC	1508.-	1/4	
	10	5SL43107RC	1508.-	1/4	
	13	5SL43137RC	1508.-	1/4	
	16	5SL43167RC	1508.-	1/4	
	20	5SL43207RC	1508.-	1/4	
	25	5SL43257RC	1508.-	1/4	
	32	5SL43327RC	1508.-	1/4	
	40	5SL43407RC	2282.-	1/4	
	50	5SL43507RC	2282.-	1/4	
	63	5SL43637RC	2282.-	1/4	
	4P, 415V AC	4	5SL44057RC	2546.-	1/3
	2	5SL44027RC	2546.-	1/3	
	3	5SL44037RC	2546.-	1/3	
	4	5SL44047RC	2546.-	1/3	
	6	5SL44067RC	2089.-	1/3	
	8	5SL44087RC	2089.-	1/3	
	10	5SL44107RC	2089.-	1/3	
	13	5SL44137RC	2089.-	1/3	
	16	5SL44167RC	2089.-	1/3	
	20	5SL44207RC	2089.-	1/3	
	25	5SL44257RC	2089.-	1/3	
	32	5SL44327RC	2089.-	1/3	
	40	5SL44407RC	2849.-	1/3	
	50	5SL44507RC	2849.-	1/3	
	63	5SL44637RC	2849.-	1/3	

■ Stock items

Note: * MRP - Maximum Retail Price # 1MW (Module Width) = 18mm

** Purchase MOQ for our authorised dealers is in multiples of standard packing, contact Siemens Sales Office for further details

^ Suitable for DC networks in Telecom application; 60V DC for 1P & 110V DC for 2P (contact sales office for connection diagram)

Betagard Miniature Circuit Breakers 5SL7, with C characteristics



- Standards: IS/IEC 60898-1:2015
- Voltage: Un 240/415V, 50....60Hz
- Breaking capacity: 15kA¹⁾ as per IS/IEC 60898-1

	Rated Current I_n (A)	MW [#]	Reference No	Unit MRP* ₹	Std. Pkg.** (Nos.)
	2	1	5SL71027RC	505.-	1/12
	4		5SL71047RC	505.-	1/12
	6		5SL71067RC	435.-	1/12
	10		5SL71107RC	435.-	1/12
	16		5SL71167RC	435.-	1/12
	20		5SL71207RC	435.-	1/12
	25		5SL71257RC	435.-	1/12
	32		5SL71327RC	435.-	1/12
	40		5SL71407RC	685.-	1/12
	50		5SL71507RC	685.-	1/12
63	5SL71637RC	685.-	1/12		
	2	2	5SL72027RC	1360.-	1/6
	4		5SL72047RC	1360.-	1/6
	6		5SL72067RC	990.-	1/6
	10		5SL72107RC	990.-	1/6
	16		5SL72167RC	990.-	1/6
	20		5SL72207RC	990.-	1/6
	25		5SL72257RC	990.-	1/6
	32		5SL72327RC	990.-	1/6
	40		5SL72407RC	1490.-	1/6
	50		5SL72507RC	1490.-	1/6
63	5SL72637RC	1490.-	1/6		
	2	3	5SL73027RC	2085.-	1/4
	4		5SL73047RC	2085.-	1/4
	6		5SL73067RC	1570.-	1/4
	10		5SL73107RC	1570.-	1/4
	16		5SL73167RC	1570.-	1/4
	20		5SL73207RC	1570.-	1/4
	25		5SL73257RC	1570.-	1/4
	32		5SL73327RC	1570.-	1/4
	40		5SL73407RC	2345.-	1/4
	50		5SL73507RC	2345.-	1/4
63	5SL73637RC	2345.-	1/4		
	2	4	5SL74027RC	2630.-	1/3
	4		5SL74047RC	2630.-	1/3
	6		5SL74067RC	2105.-	1/3
	10		5SL74107RC	2105.-	1/3
	16		5SL74167RC	2105.-	1/3
	20		5SL74207RC	2105.-	1/3
	25		5SL74257RC	2105.-	1/3
	32		5SL74327RC	2105.-	1/3
	40		5SL74407RC	2950.-	1/3
	50		5SL74507RC	2950.-	1/3
63	5SL74637RC	2950.-	1/3		

Note:

* MRP - Maximum Retail Price # 1MW (Module Width) = 18mm

** Purchase MOQ for our authorised dealers is in multiples of standard packing, contact Siemens Sales Office for further details

¹⁾ Breaking capacity 63A - 10kA

Betagard Miniature Circuit Breakers 5SL7, with D characteristics

- Standards: IS/IEC 60898-1
- Voltage: Un 240/415V, 50....60Hz
- Breaking capacity: 15kA¹⁾ as per IS/IEC 60898-1

	Rated Current I _n (A)	MW [#]	Reference No	Unit MRP* ₹	Std. Pkg.** (Nos.)
1P, 240/415V AC					
	2	1	5SL71028RC	505.-	1/12
	4		5SL71048RC	505.-	1/12
	6		5SL71068RC	455.-	1/12
	10		5SL71108RC	455.-	1/12
	16		5SL71168RC	455.-	1/12
	20		5SL71208RC	455.-	1/12
	25		5SL71258RC	455.-	1/12
	32		5SL71328RC	455.-	1/12
	40		5SL71408RC	880.-	1/12
	50		5SL71508RC	880.-	1/12
63	5SL71638RC	880.-	1/12		
2P, 415V AC					
	2	2	5SL72028RC	1360.-	1/6
	4		5SL72048RC	1360.-	1/6
	6		5SL72068RC	1040.-	1/6
	10		5SL72108RC	1040.-	1/6
	16		5SL72168RC	1040.-	1/6
	20		5SL72208RC	1040.-	1/6
	25		5SL72258RC	1040.-	1/6
	32		5SL72328RC	1040.-	1/6
	40		5SL72408RC	1925.-	1/6
	50		5SL72508RC	1925.-	1/6
63	5SL72638RC	1925.-	1/6		
3P, 415V AC					
	2	3	5SL73028RC	2085.-	1/4
	4		5SL73048RC	2085.-	1/4
	6		5SL73068RC	1650.-	1/4
	10		5SL73108RC	1650.-	1/4
	16		5SL73168RC	1650.-	1/4
	20		5SL73208RC	1650.-	1/4
	25		5SL73258RC	1650.-	1/4
	32		5SL73328RC	1650.-	1/4
	40		5SL73408RC	3005.-	1/4
	50		5SL73508RC	3005.-	1/4
63	5SL73638RC	3005.-	1/4		
4P, 415V AC					
	2	4	5SL74028RC	2670.-	1/3
	4		5SL74048RC	2670.-	1/3
	6		5SL74068RC	2185.-	1/3
	10		5SL74108RC	2185.-	1/3
	16		5SL74168RC	2185.-	1/3
	20		5SL74208RC	2185.-	1/3
	25		5SL74258RC	2185.-	1/3
	32		5SL74328RC	2185.-	1/3
	40		5SL74408RC	3770.-	1/3
	50		5SL74508RC	3770.-	1/3
63	5SL74638RC	3770.-	1/3		

Note:

* MRP - Maximum Retail Price # 1MW (Module Width) = 18mm

** Purchase MOQ for our authorised dealers is in multiples of standard packing, contact Siemens Sales Office for further details

¹⁾ Breaking capacity 40A - 63A: 10kA

Betagard Circuit Breakers 5SY4, with C characteristics

- Standards: IEC/EN 60947-2
- Voltage: Un 230/400V
- Breaking capacity: 10kA as per IEC/EN 60947-2

C characteristic



10000A		Rated Current I_n (A)	MW [#]	Reference No	Unit MRP* ₹	Std. Pkg.** (Nos.)
	1Pole	80A	1	5SY41807CC	3295.-	1/1
	2Pole		2	5SY42807CC	6475.-	1/1
	3Pole		3	5SY43807CC	10110.-	1/1
	4Pole		4	5SY44807CC	14485.-	1/1

Betagard Miniature Circuit Breakers 5SP4, with C/D characteristics



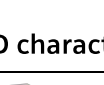

- Standards: IS/IEC 60898-1:2002
- Voltage: Un 240/415V
- Breaking capacity: 10kA as per IS/IEC 60898-1:2002
- With ISI marking: CM/L No. 2255548

C characteristic

10000A		Rated Current I_n (A)	MW [#]	Reference No	Unit MRP* ₹	Std. Pkg.** (Nos.)
	1-pole	80	1.5	5SP41807RC	3175.-	1/10
		100		5SP41917RC	3350.-	1/10
		125		5SP41927RC	3800.-	1/10
	2-pole	80	3	5SP42807RC	6235.-	1/5
		100		5SP42917RC	6575.-	1/5
		125		5SP42927RC	7440.-	1/5
	3-pole	80	4.5	5SP43807RC	9735.-	1
		100		5SP43917RC	9990.-	1
		125		5SP43927RC	11450.-	1
	4-pole	80	6	5SP44807RC	13960.-	1
		100		5SP44917RC	14365.-	1
		125		5SP44927RC	16350.-	1

D characteristic

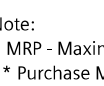
	1-pole	80	1.5	5SP41808RC	3500.-	1/10
		100		5SP41918RC	3665.-	1/10
	2-pole	80	3	5SP42808RC	7020.-	1/5
		100		5SP42918RC	7445.-	1/5
	3-pole	80	4.5	5SP43808RC	10815.-	1
		100		5SP43918RC	10920.-	1
	4-pole	80	6	5SP44808RC	15210.-	1
		100		5SP44918RC	15595.-	1

Note:



* MRP - Maximum Retail Price

1MW (Module Width) = 18mm

** Purchase MOQ for our authorised dealers is in multiples of standard packing, contact Siemens Sales Office for further details

Betagard Circuit Breakers 5SL5, DC with C Characteristics

- Standards: IS/IEC 60947-2
- Voltage: 220V DC/1P & 440VDC/2P^
- Breaking capacity: 10kA as per IS/IEC 60947-2

10000A	Rated Current I_n (A)	MW#	Reference No	Unit MRP* ₹	Std. Pkg.** (Nos.)	
	1P, 220V DC	0.5	1	5SL51057RC	770.-	1/12
	1	1	5SL51017RC	770.-	1/12	
	2	5SL51027RC	825.-	1/12		
	3	5SL51037RC	870.-	1/12		
	4	5SL51047RC	825.-	1/12		
	6	5SL51067RC	705.-	1/12		
	8	5SL51087RC	740.-	1/12		
	10	5SL51107RC	705.-	1/12		
	16	5SL51167RC	705.-	1/12		
	20	5SL51207RC	705.-	1/12		
	25	5SL51257RC	705.-	1/12		
	32	5SL51327RC	705.-	1/12		
	40	5SL51407RC	1050.-	1/12		
	50	5SL51507RC	1050.-	1/12		
63	5SL51637RC	1050.-	1/12			
	2P, 440V DC	0.5	2	5SL52057RC	1670.-	1/6
	1	5SL52017RC	1670.-	1/6		
	2	5SL52027RC	1670.-	1/6		
	3	5SL52037RC	1750.-	1/6		
	4	5SL52047RC	1670.-	1/6		
	6	5SL52067RC	1465.-	1/6		
	8	5SL52087RC	1535.-	1/6		
	10	5SL52107RC	1465.-	1/6		
	16	5SL52167RC	1465.-	1/6		
	20	5SL52207RC	1465.-	1/6		
	25	5SL52257RC	1465.-	1/6		
	32	5SL52327RC	1465.-	1/6		
	40	5SL52407RC	2165.-	1/6		
	50	5SL52507RC	2165.-	1/6		
63	5SL52637RC	2165.-	1/6			



■ Stock items

^ For connection diagram, contact Siemens Sales Office for further details.

• Also available DC Circuit Breakers for Solar applications - contact Siemens sales office for further details.

Betagard Isolators 5TL1

- Standard: IS/IEC 60947-3
- Voltage: 440V AC

	Rated Current I_n (A)	MW#	Reference No	Unit MRP* ₹	Std. Pkg.** (Nos.)	
	2-pole	32	2	5TL12320	640.-	1/1
	40	5TL12400	655.-	1/1		
	63	5TL12630	865.-	1/1		
	80	5TL12800	1135.-	1/1		
	100	5TL12910	1440.-	1/1		
	125	5TL12920	1495.-	1/1		
	3-pole	32	3	5TL13320	1055.-	1/1
	40	5TL13400	1225.-	1/1		
	63	5TL13630	1365.-	1/1		
	80	5TL13800	1655.-	1/1		
	100	5TL13910	1740.-	1/1		
	125	5TL13920	1880.-	1/1		
	4-pole	32	4	5TL14320	1205.-	1/1
	40	5TL14400	1435.-	1/1		
	63	5TL14630	1630.-	1/1		
	80	5TL14800	1960.-	1/1		
	100	5TL14910	2355.-	1/1		
	125	5TL14920	2560.-	1/1		

Note:

* MRP - Maximum Retail Price # 1MW (Module Width) = 18mm

** Purchase MOQ for our authorised dealers is in multiples of standard packing, contact Siemens Sales Office for further details

SIEMENS
Ingenuity for life

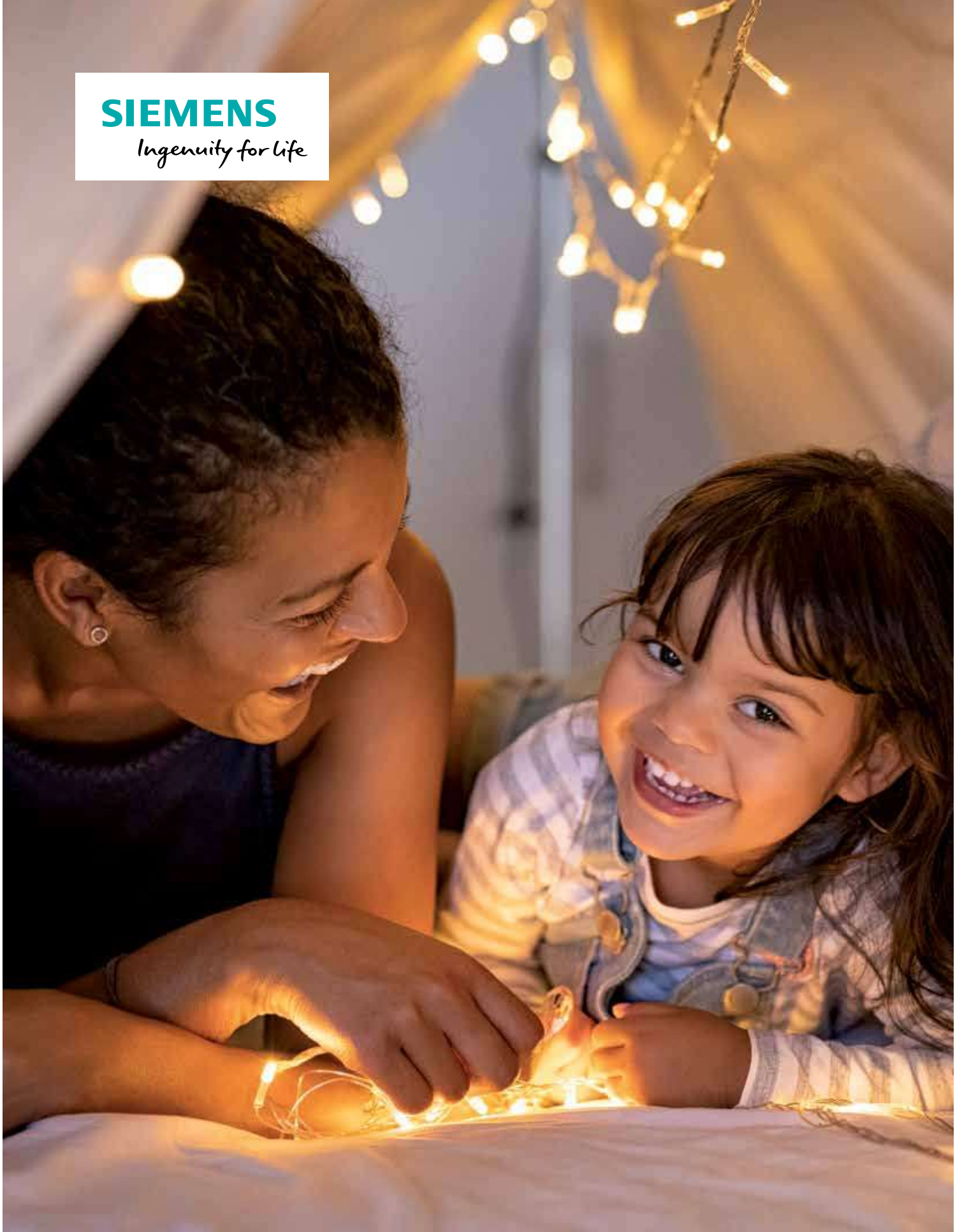

Celebrate Life, while we Care.



Betagard 5SV

Residual Current Circuit Breakers



In the event of a fault, residual current protective devices reliably disconnect power to protect humans

Fault protection

"Protection against indirect contact"

Protects people in the event of contact with electrically conductive parts, if a risk exists as a result of a fault due to the magnitude or duration of the touch voltage



Additional protection

"Protection in case of direct contact" with $I_{\Delta n} = 30\text{mA}$

Protects individuals if they come in direct contact with an active live part under normal operating condition



Fire protection

"Protection from insulation faults" with $I_{\Delta n} = 300\text{mA}$

For the prevention of fires which can be caused by insulation faults in locations exposed to fire hazards



Surge current withstand capability

"Protection surge currents" with $8/20\mu\text{s} > 1000\text{ Amp}$

For Type "A"  have a surge current capability to avoid nuisance tripping





Betagard Residual Current Circuit Breakers 5SV





- Standards: IS 12640 (Part 1):2016/IEC 61008-1:2012
- Voltage: 240/415VAC, 50Hz
- With ISI marking: CM/L No. 7676092

Type AC, applicable in networks for AC residual currents

	Rated residual current $I_{\Delta n}$ (mA)	Rated Current I_n (A)	MW#	Reference No	Unit MRP* ₹	Std. Pkg.** (Nos.)
	30	25	2	5SV43120RC	3355.-	1
	100	25		5SV44120RC	3500.-	1
	300	25		5SV46120RC	3620.-	1
	30	40		5SV43140RC	3930.-	1
	100	40		5SV44140RC	4100.-	1
	300	40		5SV46140RC	4255.-	1
	30	63		5SV43160RC	5255.-	1
	100	63		5SV44160RC	5295.-	1
	300	63		5SV46160RC	5630.-	1
	30	80		5SV43170RC	8130.-	1
	100	80		5SV44170RC	8450.-	1
	300	80		5SV46170RC	8450.-	1
	30	25	4	5SV43420RC	4490.-	1
	100	25		5SV44420RC	4655.-	1
	300	25		5SV46420RC	4830.-	1
	30	40		5SV43440RC	4545.-	1
	100	40		5SV44440RC	4720.-	1
	300	40		5SV46440RC	4900.-	1
	30	63		5SV43460RC	5295.-	1
	100	63		5SV44460RC	5505.-	1
	300	63		5SV46460RC	5700.-	1
	30	80		5SV43470RC	8130.-	1
	100	80		5SV44470RC	8450.-	1
	300	80		5SV46470RC	8450.-	1

Type A, applicable in networks with AC and/or pulsating DC residual currents

	30	25	2	5SV33126RC	6135.-	1
	100	25		5SV34126RC	7225.-	1
	300	25		5SV36126RC	7225.-	1
	30	40		5SV33146RC	6955.-	1
	100	40		5SV34146RC	7245.-	1
	300	40		5SV36146RC	7245.-	1
	30	63		5SV33166RC	10115.-	1
	100	63		5SV34166RC	10400.-	1
	300	63		5SV36166RC	9905.-	1
	30	80		5SV33176RC	10880.-	1
	100	80		5SV34176RC	11700.-	1
	300	80		5SV36176RC	11140.-	1
	30	25	4	5SV33426RC	7275.-	1
	100	25		5SV34426RC	8975.-	1
	300	25		5SV36426RC	8975.-	1
	30	40		5SV33446RC	8030.-	1
	100	40		5SV34446RC	8975.-	1
	300	40		5SV36446RC	8975.-	1
	30	63		5SV33466RC	9170.-	1
	100	63		5SV34466RC	9115.-	1
	300	63		5SV36466RC	9115.-	1
	30	80		5SV33476RC	11025.-	1
	100	80		5SV34476RC	11700.-	1
	300	80		5SV36476RC	11140.-	1

■ Stock items

Note:

* MRP - Maximum Retail Price # 1MW (Module Width) = 18mm

** Purchase MOQ for our authorised dealers is in multiples of standard packing, contact Siemens Sales Office for further details

Betagard Residual Current Circuit Breakers 5SM3

- Standards: IS 12640 (Part 1):2016/IEC 61008-1:2012
- Voltage: 240/415VAC, 50Hz
- With ISI marking: CM/L No. 7676092

Type AC, applicable in networks for AC residual currents

	Rated residual current $I_{\Delta n}$ (mA)	Rated Current I_n (A)	MW [#]	Reference No	Unit MRP* ₹	Std. Pkg.** (Nos.)	
	4 Pole	30	100	4	5SM33480RC	42410.-	1
		100	100	5SM34480RC	37625.-	1	
		300	100	5SM36480RC	35670.-	1	
		30	125	5SM33450RC	42410.-	1	
		100	125	5SM34450RC	37625.-	1	
		300	125	5SM36450RC	35670.-	1	
		500	125	5SM37450RC	41075.-	1	

Type A, applicable in networks with AC and/or pulsating DC residual currents

	4 Pole	30	100	4	5SM33486RC	38870.-	1
		100	100	5SM34486RC	37470.-	1	
		300	100	5SM36486RC	38070.-	1	
		30	125	5SM33456RC	38870.-	1	
		100	125	5SM34456RC	37470.-	1	
		300	125	5SM36456RC	41530.-	1	
		500	125	5SM37456RC	42795.-	1	

Note:

* MRP - Maximum Retail Price # 1MW (Module Width) = 18mm

** Purchase MOQ for our authorised dealers is in multiples of standard packing, contact Siemens Sales Office for further details

The right type for your application..

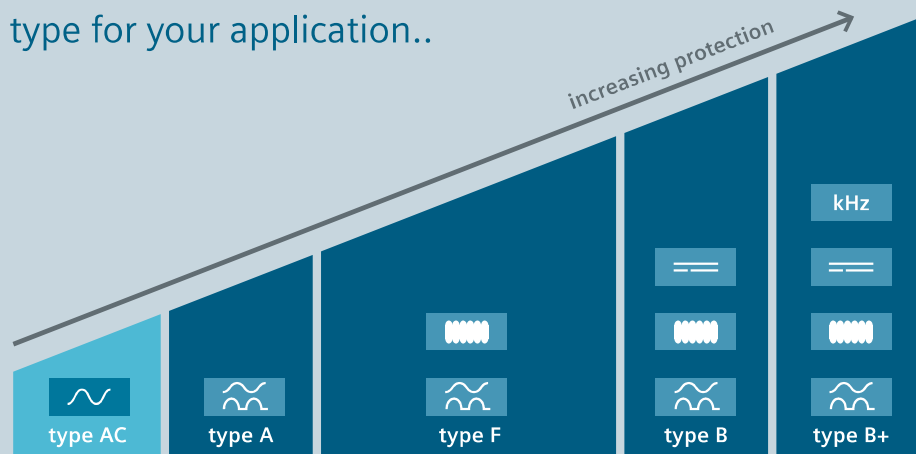

- sinusoidal alternating currents (type AC)
- pulsating DC residual currents (type A)

- electrical loads with frequency converters in the single-phase alternating currents (type F)

- smooth DC residual currents (type B/B+)

More information:
siemens.com/rccb

Betagard Residual Current Breaker Operators 5SU1, 10kA





- Standards: IS 12640, Part 2:2016/IEC 61009-1:2012
- Voltage: 240/415Vac, 50Hz
- With ISI marking: CM/L No. 7676193



Type AC, with C Characteristics (in 2 module size)[§]

	Rated residual current I _{Δn} (mA)	Rated Current I _n (A)	MW [#]	Reference No	Unit MRP* ₹	Std. Pkg.** (Nos.)
	240Vac; 50Hz; 2 pole ¹⁾					
	30	6	2	5SU13541RC06	5650.-	1
	30	10		5SU13541RC10	5650.-	1
	30	16		5SU13541RC16	5650.-	1
	30	20		5SU13541RC20	5650.-	1
	30	25		5SU13541RC25	5650.-	1
	30	32		5SU13541RC32	5930.-	1
	30	40		5SU13541RC40	7015.-	1
	300	6		5SU16541RC06	5755.-	1
	300	10		5SU16541RC10	5755.-	1
	300	16		5SU16541RC16	5755.-	1
	300	20		5SU16541RC20	5755.-	1
	300	25		5SU16541RC25	5755.-	1
	300	32		5SU16541RC32	6050.-	1
300	40		5SU16541RC40	7150.-	1	

Type AC with C characteristic

	240Vac; 50Hz; 2 pole					
	30	32	4	5SU13241RC32	5580.-	1
		40		5SU13241RC40	6500.-	1
		63		5SU13241RC63	7560.-	1
	100	32		5SU14241RC32	6160.-	1
		40		5SU14241RC40	6920.-	1
		63		5SU14241RC63	8065.-	1
	300	32		5SU16241RC32	6225.-	1
		40		5SU16241RC40	6985.-	1
	63		5SU16241RC63	8065.-	1	
	415Vac; 50Hz; 4 pole					
	30	32	7	5SU13441RC32	7455.-	1
		40		5SU13441RC40	7590.-	1
		63		5SU13441RC63	9005.-	1
	100	32		5SU14441RC32	7545.-	1
		40		5SU14441RC40	7690.-	1
		63		5SU14441RC63	8840.-	1
	300	32		5SU16441RC32	7605.-	1
		40		5SU16441RC40	7755.-	1
		63		5SU16441RC63	8925.-	1

Type AC with D characteristic

	240Vac; 50Hz; 2 pole					
	30	32	4	5SU13242RC32	7195.-	1
		40		5SU13242RC40	7885.-	1
		63		5SU13242RC63	9505.-	1
	100	32		5SU14242RC32	8710.-	1
		40		5SU14242RC40	9530.-	1
		63		5SU14242RC63	10885.-	1
	300	32		5SU16242RC32	8510.-	1
		40		5SU16242RC40	9530.-	1
	63		5SU16242RC63	10900.-	1	
	415Vac; 50Hz; 4 pole					
	30	32	7	5SU13442RC32	9855.-	1
		40		5SU13442RC40	10005.-	1
		63		5SU13442RC63	11865.-	1
	100	32		5SU14442RC32	10670.-	1
		40		5SU14442RC40	11145.-	1
		63		5SU14442RC63	12355.-	1
	300	32		5SU16442RC32	10535.-	1
		40		5SU16442RC40	11255.-	1
		63		5SU16442RC63	12100.-	1

Note: * MRP - Maximum Retail Price # 1MW (Module Width) = 18mm ¹⁾ 1P+N variant

** Purchase MOQ for our authorised dealers is in multiples of standard packing, contact Siemens Sales Office for further details

§ For connecting accessories with 2P 2M RCBO add handle connector 5ST38051

Betagard Residual Current Breaker Operators 5SU1, 10kA





- Standards: IS 12640, Part 2:2016/IEC 61009-1:2012
- Voltage: 240/415Vac, 50Hz
- With ISI marking: CM/L No. 7676193



Type A, with C Characteristics (in 2 module size)[§]

	Rated residual current I _{Δn} (mA)	Rated Current I _n (A)	MW [#]	Reference No	Unit MRP* ₹	Std. Pkg.** (Nos.)
	240Vac; 50Hz; 2 pole ¹⁾					
	30	6	2	5SU13547RC06	10320.-	1
	30	10		5SU13547RC10	10320.-	1
	30	16		5SU13547RC16	10320.-	1
	30	20		5SU13547RC20	10320.-	1
	30	25		5SU13547RC25	10320.-	1
	30	32		5SU13547RC32	10790.-	1
	30	40		5SU13547RC40	13055.-	1
	300	6		5SU16547RC06	10625.-	1
	300	10		5SU16547RC10	10625.-	1
	300	16		5SU16547RC16	10625.-	1
	300	20		5SU16547RC20	10625.-	1
	300	25		5SU16547RC25	10625.-	1
	300	32		5SU16547RC32	11050.-	1
	300	40		5SU16547RC40	13325.-	1

Type A with C characteristic

	240Vac; 50Hz; 2 pole					
	30	32	4	5SU13247RC32	10110.-	1
		40		5SU13247RC40	11125.-	1
		63		5SU13247RC63	12585.-	1
	100	32		5SU14247RC32	10790.-	1
		40		5SU14247RC40	11985.-	1
		63		5SU14247RC63	13620.-	1
	300	32		5SU16247RC32	10790.-	1
		40		5SU16247RC40	11985.-	1
63		5SU16247RC63		13620.-	1	
	415Vac; 50Hz; 4 pole					
	30	32	7	5SU13447RC32	12380.-	1
		40		5SU13447RC40	12890.-	1
		63		5SU13447RC63	14745.-	1
	100	32		5SU14447RC32	13280.-	1
		40		5SU14447RC40	13535.-	1
		63		5SU14447RC63	15130.-	1
	300	32		5SU16447RC32	13280.-	1
		40		5SU16447RC40	13770.-	1
		63		5SU16447RC63	15365.-	1

Type A with D characteristic

	240Vac; 50Hz; 2 pole					
	30	32	4	5SU13248RC32	11800.-	1
		40		5SU13248RC40	13315.-	1
		63		5SU13248RC63	15150.-	1
	100	32		5SU14248RC32	12695.-	1
		40		5SU14248RC40	14120.-	1
		63		5SU14248RC63	16085.-	1
	300	32		5SU16248RC32	12695.-	1
		40		5SU16248RC40	14120.-	1
63		5SU16248RC63		16085.-	1	
	415Vac; 50Hz; 4 pole					
	30	32	7	5SU13448RC32	14605.-	1
		40		5SU13448RC40	14790.-	1
		63		5SU13448RC63	17440.-	1
	100	32		5SU14448RC32	15385.-	1
		40		5SU14448RC40	16440.-	1
		63		5SU14448RC63	17900.-	1
	300	32		5SU16448RC32	15385.-	1
		40		5SU16448RC40	16440.-	1
		63		5SU16448RC63	17905.-	1

Note: * MRP - Maximum Retail Price







1MW (Module Width) = 18mm

¹⁾ 1P+N variant

** Purchase MOQ for our authorised dealers is in multiples of standard packing, contact Siemens Sales Office for further details

[§] For connecting accessories with 2P 2M RCBO add handle connector 5ST38051

Accessories for 5SL / 5SY / 5SP MCBs, 5TL isolators, 5SV/5SM RCCBs and 5SU1 RCBOs

	Item Description	Reference No	Unit MRP* ₹	Std. Pkg.** (Nos.)
	Aux contact block (For 5SL/5SY/5SP4/5TL/5SV/5SU1)			
	1NO+1NC	5ST3010	1205.-	12
	2NO	5ST3011	1225.-	1
	2NC	5ST3012	1225.-	1
	1CO	5ST3016	1915.-	1
	Fault signal contact (For 5SL/5SY/5SP4/5SV/5SU1)			
	1NO+1NC	5ST3020	1770.-	1
	2NO	5ST3021	1800.-	1
	2NC	5ST3022	1800.-	1
	Shunt release (For 5SL5/5SL7/5SY/5SP4/5SV/5SU1)			
110...415V AC	5ST3030	4970.-	1/5	
24...48V DC	5ST3031	4970.-	1/5	
Auxiliary and fault signal changeover contact (For 5SL/5SY/5SP4/5TL/5SV/5SU1)	5ST3062	5425.-	1	
Auxiliary switch - 1CO Fault contact - 1CO				
Auxiliary contact block for 5SM3 100-125A 4pole				
1NO+1NC	5SW3330	5070.-	1/10	
	Undervoltage release (For 5SL5/5SL7/5SY/5SP4/5SV/5SU1)			
	With integrated aux. switch			
	230V AC	5ST3040	6665.-	1/5
	110V DC	5ST3041	6665.-	1/5
	24V DC	5ST3042	6665.-	1/5
	Without integrated aux. switch			
	230V AC	5ST3043	6665.-	1/5
	110V DC	5ST3044	6665.-	1/5
	24V DC	5ST3045	6665.-	1/5
		Remote control mechanism unit		
Basic version for 5SL,5SY,5TL1 and 5SU1 (1P+N only) (12-30)VAC & (12-48)VDC, 1.5MW		5ST3053	29735.-	1
230VAC, 2MW		5ST3054	29735.-	1
Power version for 5SL,5SY,5TL1 and 5SU1 (12-30)VAC & (12-48)VDC, 2MW		5ST3055	50320.-	1
230VAC, 2MW		5ST3056	50320.-	1
Adapter for Remote control mechanism (To be ordered along with 5ST305X basic unit)				
For 5SL - 1P & 2P, 5SV - 4P		5ST38206	625.-	1
For 5SL - 3P & 4P		5ST38207	625.-	1
For 5SY - 1P & 2P and For 5SU1 [^] - 2P, 4M		5ST38201	625.-	1
For 5SY - 3P & 4P and For 5SU1 [^] - 4P, 7M		5ST38202	625.-	1
For 5SU1 - 2P, 2M	5ST38205	625.-	1	
[^] Add-on block for 5SU1 to be ordered along with Adapter	5ST38203	1370.-	1	
	Handle locking device			
	for 5SP and 5SY circuit breakers for padlock with max. 3mm shackle	5ST3801	615.-	1
	for 5SL circuit breakers, 5TL1 isolators and 5SV residual current circuit breakers for padlock with max. 3 to 6 mm shackle	5ST3806	585.-	5
	Pad locks for 5ST3801 and 5ST3806 handle locking devices	5ST3802	395.-	5
	Handle connector for 2P, 2M 5SU1 RCBO ⁵	5ST38051	1230.-	1

Betagard Rotary Handle Assembly

	Item Description	Reference No.	Unit MRP* ₹	Std. Pkg.** (Nos.)
	Rotary Handle Assembly for 5SY, 5SL, 5SP and 5TL1 series of MCBs/ Isolators ⁵⁵	5ST38140RC	2210.-	1

Note: * MRP - Maximum Retail Price # 1MW (Module Width) = 18mm

\$ For 2P, 2M RCBOs, the accessories can be used along with Handle connector only

\$\$ Not suitable for 1P variants

** Purchase MOQ for our authorised dealers is in multiples of standard packing, contact Siemens Sales Office for further details

SIEMENS

Ingenuity for life



SIRENEW

Power Distribution Solution
for RENEWables

thanks to

SIARC

technology

World's smallest AFDD

Thanks to innovative SIARC technology, the AFDD is the only protection device that detects parallel as well as serial arcing faults. Common causes are, among others:

First arc fault detection device (AFDD) in the IEC market (2012) for preventive fire protection
First AFDD with integrated MCB in 1 modular width (MW)

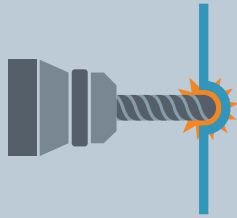

damaged wire insulation



crushed cables



rodent damage

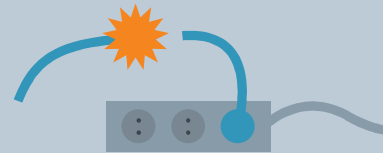

broken cables

#1 Be the first to play it safe with the 5SV6 AFDD

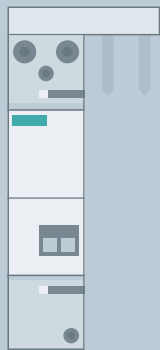

Arc fault detection unit

+

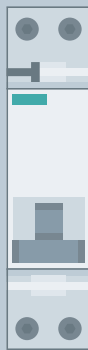

Miniature circuit breaker

=

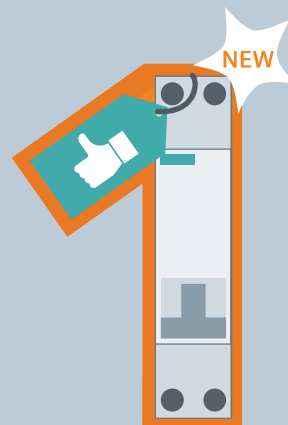

5SV6 AFDD

1 MW

AFDDs are strongly recommended!

Comprehensive portfolio for preventive fire protection

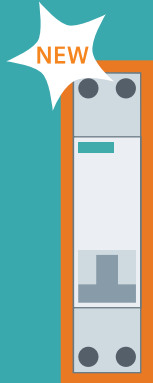

5SV6 AFDD
+ integrated MCB = 1 MW

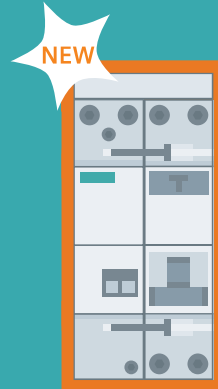

5SM6 AFD unit
+ 5SV1 RCBO = 2 MW



5SM6 AFD unit
+ 5SY60 MCB = 2 MW



5SM6 AFD unit
+ 5SU1 RCBO = 3 MW

More information available at [siemens.com/afdd](https://www.siemens.com/afdd)

It's Time to Act Now!

Preventive, Proven, Standard compliant

[siemens.com/protection-concept](https://www.siemens.com/protection-concept)



SIEMENS
Ingenuity for life

Arc Fault Detection Device

It's Time to Act Now!

With the 5SV6 Arc Fault Detection Device (AFDD), Siemens presents the third generation of fire-prevention product. The 5SV6 Arc Fault Detection Device with integrated miniature circuit breaker (MCB) is the first device on the IEC market with just one module width and is the smallest of its kind worldwide.

A standard-compliant expansion of the electrical installation by protection against electrical fires is thus always possible – easily and without the need for additional space.

www.siemens.com/afd-units

NEW



The smart solution.

Whether in an existing plant or a new installation – the 5SV6 AFDD and 5SM6 AFD unit can be deployed in any distribution board. It quickly identifies dangerous faults caused by parallel or serial arcing faults and switches off before a fire occurs. The AFDD detects operational arcing faults and only trips in the event of an actual fault.

5SV6 AFDDs with Integrated MCB & RCBO in 18mm width

	Rating	With integrated MCB		With integrated RCBO	Unit LP* ₹
		B characteristic	C characteristic	30mA, Type AC, C characteristic	
	6A	5SV60166KK06	5SV60167KK06	5SV63167KK06	Price on Request
	10A	5SV60166KK10	5SV60167KK10	5SV63167KK10	
	13A	5SV60166KK13	5SV60167KK13	5SV63167KK13	
	16A	5SV60166KK16	5SV60167KK16	5SV63167KK16	
	20A	5SV60166KK20	5SV60167KK20	5SV63167KK20	
	25A	5SV60166KK25	5SV60167KK25	5SV63167KK25	
	32A	5SV60166KK32	5SV60167KK32	5SV63167KK32	
	40A	5SV60166KK40	5SV60167KK40	5SV63167KK40	

5SM6 AFDD with integrated MCB

	Rating	Module width	Reference No.	Description	Unit LP* ₹
	16A	2	5SM60111XX02	AFDD 16A, 230V, 2MW (Integrated with 1MW, 1+N, 16A MCB)	Price on Request

5SM6 AFD units (Suitable for add on with RCBO)

	Rating	Module width	Reference No.	Description	Unit LP* ₹
	16A	3	5SM60212	AFD Unit 1-16A, 230V, 1MW (Suitable for 2P 2M, 5SU1 RCBO)	Price on Request
	40A	3	5SM60242	AFD Unit 1-40A, 230V, 1MW (Suitable for 2P 2M, 5SU1 RCBO)	

* LP - List Price

SIEMENS
Ingenuity for life









Perfect blend of beauty and features with assured performance

Betagard Distribution Boards

- Complete range for Residential, Commercial and Industrial Infrastructures
- DBs offer latest design with highest aesthetic appeal
- DBs available with type testing as per the latest applicable standards
- User friendly design offers ease during maintenance and assists the installer for correct installation

Betagard Distribution Boards 8GB32 # SPN and TPN DBs

- Type Tested as per IEC 61439 Standards at third party and internal test laboratories
- Available in IP 20 and IP 43 Versions
- Single Door, Metal Double Door and Acrylic Double Door options available
- Standard Wire Way Boxes available for all Single Door and Double Door DBs
- Additional safety with Insulated Shorting Links, Shrouded Neutral Links and Door Earthing
- TPN DBs can be easily made suitable for PPI configuration using TPN to PPI Conversion Kits
- Detachable DIN rail assembly and intermittent door facilitates ease in Wiring during installation and maintenance
- DBs are subjected to Seven tank process and treated with premium quality powder coating
- Cement Masking Sheet protects the DBs against extreme site conditions

	Item Description	Incoming Slots (MW)	Outgoing Slots (MW)	Total Slots (MW)	Reference No	Unit MRP* ₹	Std. Pkg.** (Nos.)
Metal Enclosures, IP20:							
	1 Module	–	–	1	8GB32100RC01	575.-	1/20
	2 Module	–	–	2	8GB32100RC02	850.-	1/20
	3 Module	–	–	3	8GB32100RC03	850.-	1/20
	4 Module	–	–	4	8GB32100RC04	850.-	1/20
	6 Module	–	–	6	8GB32100RC06	1125.-	1/20
	8 Module	–	–	8	8GB32100RC08	1325.-	1/10
SPN Single Door DBs#, IP20:							
	6 Module	2	4	6	8GB32101RC06	1685.-	1
	8 Module	2	6	8	8GB32101RC08	1790.-	1
	10 Module	2	8	10	8GB32101RC10	2155.-	1
	12 Module	2	10	12	8GB32101RC12	2235.-	1
	14 Module	2	12	14	8GB32101RC14	2525.-	1
	16 Module	2	14	16	8GB32101RC16	2720.-	1
SPN Metal Double Door DBs#, IP 43:							
	6 Module	2	4	6	8GB32102RC06	2635.-	1
	8 Module	2	6	8	8GB32102RC08	2735.-	1
	10 Module	2	8	10	8GB32102RC10	3185.-	1
	12 Module	2	10	12	8GB32102RC12	3270.-	1
	14 Module	2	12	14	8GB32102RC14	3810.-	1
	16 Module	2	14	16	8GB32102RC16	3905.-	1
SPN Acrylic Double Door DBs#, IP 43:							
	6 Module	2	4	6	8GB32103RC06	3095.-	1
	8 Module	2	6	8	8GB32103RC08	3270.-	1
	10 Module	2	8	10	8GB32103RC10	3810.-	1
	12 Module	2	10	12	8GB32103RC12	4090.-	1
	14 Module	2	12	14	8GB32103RC14	4270.-	1
	16 Module	2	14	16	8GB32103RC16	4450.-	1
Wire Way Box For SPN Single Door IP 20 DBs:							
	For 6 MOD SPN Single door DB	–	–	–	8GB32106RC06	1110.-	1/5
	For 8 MOD SPN Single door DB	–	–	–	8GB32106RC08	1110.-	1/5
	For 10 MOD SPN Single door DB	–	–	–	8GB32106RC10	1195.-	1/5
	For 12 MOD SPN Single door DB	–	–	–	8GB32106RC12	1195.-	1/5
	For 14 MOD SPN Single door DB	–	–	–	8GB32106RC14	1380.-	1/5
	For 16 MOD SPN Single door DB	–	–	–	8GB32106RC16	1380.-	1/5
Wire Way Box For SPN Double Door IP 43 DBs:							
	For 6 MOD SPN Double door DB	–	–	–	8GB32107RC06	1195.-	1/5
	For 8 MOD SPN Double door DB	–	–	–	8GB32107RC08	1195.-	1/5
	For 10 MOD SPN Double door DB	–	–	–	8GB32107RC10	1295.-	1/5
	For 12 MOD SPN Double door DB	–	–	–	8GB32107RC12	1295.-	1/5
	For 14 MOD SPN Double door DB	–	–	–	8GB32107RC14	1650.-	1/5
	For 16 MOD SPN Double door DB	–	–	–	8GB32107RC16	1650.-	1/5

Note: * MRP - Maximum Retail Price # Also available in flat door option

For Customized Solutions in Distribution Boards please Contact our sales Office

** Purchase MOQ for our authorised dealers is in multiples of standard packing, contact Siemens Sales Office for further details

Betagard Distribution Boards 8GB32 # SPN and TPN DBs

	Item Description	Incoming Slots (MW)	Outgoing Slots (MW)	Total Slots (MW)	Reference No	Unit MRP* ₹	Std. Pkg.** (Nos.)
TPN Single Door DBs#, IP20:							
	4 way	8	12	20	8GB32201RC04	4240.-	1
	6 way	8	18	26	8GB32201RC06	4815.-	1
	8 way	8	24	32	8GB32201RC08	5815.-	1
	10 way	8	30	38	8GB32201RC10	8430.-	1
	12 way	8	36	44	8GB32201RC12	8610.-	1
	14 way	8	42	50	8GB32201RC14	9875.-	1
	16 way	8	48	56	8GB32201RC16	10245.-	1
TPN Metal Double Door DBs#, IP 43							
	4 way	8	12	20	8GB32202RC04	5180.-	1
	6 way	8	18	26	8GB32202RC06	6260.-	1
	8 way	8	24	32	8GB32202RC08	7525.-	1
	10 way	8	30	38	8GB32202RC10	10875.-	1
	12 way	8	36	44	8GB32202RC12	11145.-	1
	14 way	8	42	50	8GB32202RC14	13225.-	1
	16 way	8	48	56	8GB32202RC16	13600.-	1
TPN Acrylic Double Door DBs#, IP 43							
	4 way	8	12	20	8GB32203RC04	6260.-	1
	6 way	8	18	26	8GB32203RC06	7710.-	1
	8 way	8	24	32	8GB32203RC08	9245.-	1
	10 way	8	30	38	8GB32203RC10	12060.-	1
	12 way	8	36	44	8GB32203RC12	14035.-	1
	14 way	8	42	50	8GB32203RC14	15035.-	1
	16 way	8	48	56	8GB32203RC16	16045.-	1
TPN to PPI Conversion Kit®							
	To convert 6 way TPN DB to 4 way TPN PPI DB				8GB32205RC04	3270.-	1/5
	To convert 8 way TPN DB to 6 way TPN PPI DB				8GB32205RC06	3810.-	1/5
	To convert 10 way TPN DB to 8 way TPN PPI DB				8GB32205RC08	3905.-	1/5
	To convert 12 way TPN DB to 10 way TPN PPI DB				8GB32205RC10	4175.-	1/5
	To convert 14 way TPN DB to 12 way TPN PPI DB				8GB32205RC12	4450.-	1/5
	To convert 16 way TPN DB to 14 way TPN PPI DB				8GB32205RC14	4715.-	1/5
Wire Way Box For TPN Single Door IP 20 DBs							
	For 4 Way TPN Single door DB	-	-	-	8GB32206RC04	1380.-	1/5
	For 6 Way TPN Single door DB	-	-	-	8GB32206RC06	1380.-	1/5
	For 8 Way TPN Single door DB	-	-	-	8GB32206RC08	2460.-	1/5
	For 10 Way TPN Single door DB	-	-	-	8GB32206RC10	3095.-	1/5
	For 12 Way TPN Single door DB	-	-	-	8GB32206RC12	3185.-	1/5
	For 14 Way TPN Single door DB	-	-	-	8GB32206RC14	3270.-	1/5
	For 16 Way TPN Single door DB	-	-	-	8GB32206RC16	3460.-	1/5
Wire Way Box For TPN Double Door IP 43 DBs							
	For 4 Way TPN Double door DB	-	-	-	8GB32207RC04	1465.-	1/5
	For 6 Way TPN Double door DB	-	-	-	8GB32207RC06	1650.-	1/5
	For 8 Way TPN Double door DB	-	-	-	8GB32207RC08	2635.-	1/5
	For 10 Way TPN Double door DB	-	-	-	8GB32207RC10	2820.-	1/5
	For 12 Way TPN Double door DB	-	-	-	8GB32207RC12	3460.-	1/5
	For 14 Way TPN Double door DB	-	-	-	8GB32207RC14	3635.-	1/5
	For 16 Way TPN Double door DB	-	-	-	8GB32207RC16	3740.-	1/5

Note: * MRP - Maximum Retail Price

@ Contains required accessories to Make the DB suitable for PPI Configuration

For Customized Solutions in Distribution Boards please Contact our sales Office

** Purchase MOQ for our authorised dealers is in multiples of standard packing, contact Siemens Sales Office for further details

Also available in flat door option

Betagard Distribution Boards 8GB32 TPN Phase Segregated DBs

Item Description	Incoming Slots (MW)	Sub - Incomer Slots (MW)	Outgoing Slots (MW)	Total Slots (MW)	Reference No	Unit MRP* ₹	Std. Pkg.** (Nos.)
TPN Phase segregated DBs, IP 20 For MCB as incomer							
4 Way	12	12	12	36	8GB32001RC04	11680.-	1
6 Way	12	12	18	42	8GB32001RC06	13135.-	1
8 Way	12	12	24	48	8GB32001RC08	15330.-	1
12 Way	12	12	36	60	8GB32001RC12	18250.-	1
TPN Phase segregated DBs, (8 segment) IP 43 For MCB as incomer							
4 way	12	12	12	36	8GB32002RC04	13870.-	1
6 way	12	12	18	42	8GB32002RC06	16060.-	1
8 way	12	12	24	48	8GB32002RC08	18250.-	1
12 way	12	12	36	60	8GB32002RC12	21900.-	1
TPN Phase segregated DBs, IP 43 for MCCB as incomer upto 160A							
6 way		12	18	30	8GB32012RC06	24810.-	1
8 way		12	24	36	8GB32012RC08	28465.-	1
12 way		12	36	48	8GB32012RC12	32115.-	1
Wire Way box for MCB Incomer, IP 43 DBs							
For 4 Way	-	-	-	-	8GB32007RC04	3645.-	1
For 6 Way	-	-	-	-	8GB32007RC06	4375.-	1
For 8 Way	-	-	-	-	8GB32007RC08	5105.-	1
For 12 Way	-	-	-	-	8GB32007RC12	5830.-	1
Wire Way box for MCCB Incomer, IP 43 DBs							
For 6 Way	-	-	-	-	8GB32017RC06	4375.-	1
For 8 Way	-	-	-	-	8GB32017RC08	5105.-	1
For 12 Way	-	-	-	-	8GB32017RC12	5830.-	1

Betagard Distribution Board 8GB

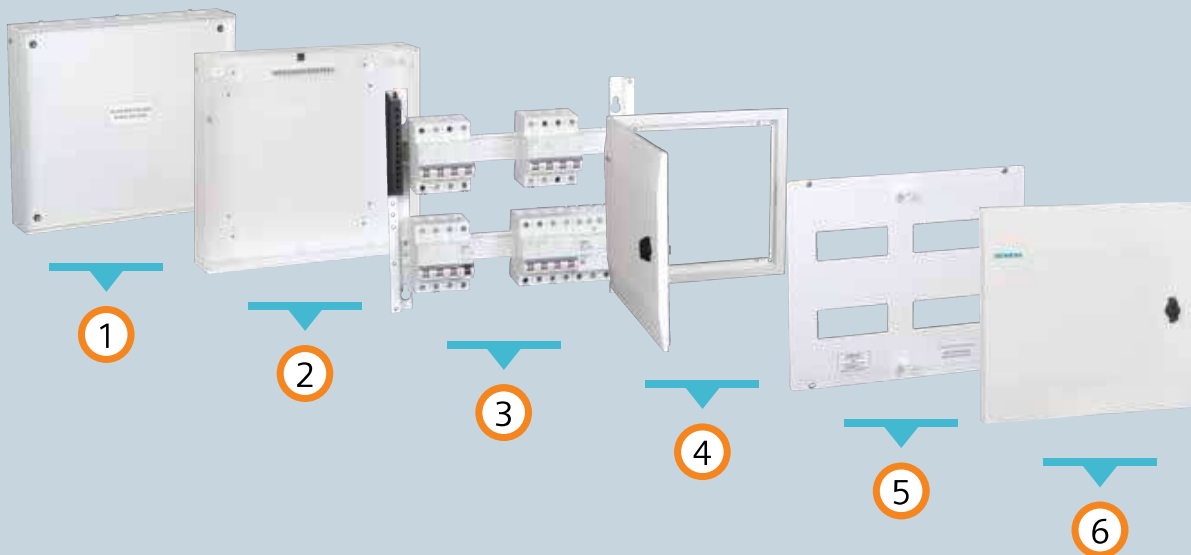

1 U-box with Cement Masking sheet

2 U-box with Earth links

3 Detachable Din-rail channel with Shrouded Neutral link

4 Door frame with Door

5 Detachable Intermittent Plate

6 Door with Quarter Turn Knob

Note: * MRP - Maximum Retail Price

** Purchase MOQ for our authorized dealers is in multiples of standard packing, contact Siemens Sales Office for further details

Betagard Distribution Boards 8GB0 SPN and TPN DBs

	Item Description	Incoming Slots (MW)	Outgoing Slots (MW)	Total Slots (MW)	Reference No	Unit MRP* ₹	Std. Pkg.** (Nos.)
Plastic Enclosure, IP20:							
	3/4 Way	–	–	4	8GB0004	300.-	1/50
	6 Way	–	–	6	8GB0006	455.-	1/25
Double Door SPN DBs, IP42 :							
	4 Way	2	4	6	8GB0204RC	2485.-	1
	6 Way	2	6	8	8GB0206RC	2560.-	1
	8 Way	2	8	10	8GB0208RC	3000.-	1
	12 Way	2	12	14	8GB0212RC	3580.-	1
	14 Way	2	14	16	8GB0214RC	3680.-	1
Double Door TPN DBs (Horizontal), IP42 :							
	4 Way	8	12	20	8GB0404HRC	4865.-	1
	6 Way	8	18	26	8GB0406HRC	5970.-	1
	8 Way	8	24	32	8GB0408HRC	7250.-	1
	12 Way	8	36	44	8GB0412HRC	10470.-	1
Double Door TPN DBs (Vertical), IP42 :							
	4 Way	8	12	20	8GB0404VRC	Price on request	1
	6 Way	8	18	26	8GB0406VRC		1
	8 Way	8	24	32	8GB0408VRC		1
	12 Way	8	36	44	8GB0412VRC		1
Double Door, Per Phase Isolation TPN DBs (Horizontal), IP42 :							
	4 Way	8	18	26	8GB0405HRC	8515.-	1
	6 Way	8	24	32	8GB0407HRC	9790.-	1
	8 Way	8	30	38	8GB0409HRC	13060.-	1
	12 Way	8	42	50	8GB0413HRC	15725.-	1
Double Door, Per Phase Isolation TPN DBs (Vertical), IP42 :							
	4 Way	8	18	26	8GB0405VRC	Price on request	1
	6 Way	8	24	32	8GB0407VRC		1
	8 Way	8	30	38	8GB0409VRC		1
	12 Way	8	42	50	8GB0413VRC		1
Double Door, Phase Segregated TPN DBs (7 segment), IP42:							
	4 Way	12	12+12	36	8GB0504	11785.-	1
	6 Way	12	12+18	42	8GB0506	13330.-	1
	8 Way	12	12+24	48	8GB0508	14870.-	1
	12 Way	12	12+36	60	8GB0512	18830.-	1

Note: * MRP - Maximum Retail Price

** Purchase MOQ for our authorized dealers is in multiples of standard packing, contact Siemens Sales Office for further details

Betagard Distribution Boards 8GB31

	Item Description	Incoming Slots (MW)	Outgoing Slots (MW)	Total Slots (MW)	Reference No	Unit MRP* ₹	Std. Pkg.** (Nos.)
Betaflex (Flexi DBs), IP42 :							
	2Row x 12Mod	—	—	24	8GB31424RC	6840.-	1
	2Row x 16Mod	—	—	32	8GB31426RC	7255.-	1
	4Row x 6Mod	—	—	24	8GB31441RC	8075.-	1
	4Row x 8Mod	—	—	32	8GB31442RC	8405.-	1
	4Row x 10Mod	—	—	40	8GB31443RC	9030.-	1
	4Row x 12Mod	—	—	48	8GB31444RC	9360.-	1
	4Row x 16Mod	—	—	64	8GB31446RC	14350.-	1
Betabus (Vertical Busbar DBs with MCB as an incomer), IP42 : (Suitable for 5SL/5SP MCBs, upto 125A as an incomer)							
	4 way	12	12	24	8GB31471RC	12065.-	1
	6 way	12	18	30	8GB31473RC	14690.-	1
	8 way	12	24	36	8GB31474RC	15490.-	1
	12 way	12	36	48	8GB31477RC	21070.-	1
Betabusplus (Vertical Busbar DBs with MCCB as an incomer), IP42 : (Suitable for 3VT1/3VA1 MCCBs, upto 160A as an incomer)							
	4 way	12	12	24	8GB31571RC	13500.-	1
	6 way	12	18	30	8GB31572RC	17035.-	1
	8 way	12	24	36	8GB31573RC	18380.-	1
	12 way	12	36	48	8GB31574RC	24480.-	1
BetaMulti (DBs for power & communication), IP42 :							
	12 way SPN, provision	2	12	14	8GB31215RC	6670.-	1
	4 Way TPN, Provision	8	12	20	8GB31220RC	8285.-	1
	6 way TPN, provision	8	18	26	8GB31221RC	8650.-	1
	8 Way TPN Provision	8	24	32	8GB31222RC	9550.-	1
Beta CO (DBs with built-in pre-wired phase changeover switches), IP42 :							
	40 A, 4 Way TPN, built-in	8	12	20	8GB31850RC	16580.-	1
	40 A, 6 Way TPN, built-in	8	18	26	8GB31851RC	17100.-	1
	40 A, 8 Way TPN, built-in	8	24	32	8GB31852RC	18005.-	1
	40 A, 12 Way TPN, built-in	8	36	44	8GB31854RC	21620.-	1
	63 A, 4 Way TPN, built-in	8	12	20	8GB31860RC	17285.-	1
	63 A, 6 Way TPN, built-in	8	18	26	8GB31861RC	17825.-	1
	63 A, 8 Way TPN, built-in	8	24	32	8GB31862RC	19445.-	1
	63 A, 12 Way TPN, built-in	8	36	44	8GB31864RC	21970.-	1
Wire Way Boxes (WWB)							
	WWB for Flexi DB,8Mod	—	—	—	8GB9908FWWNT	1840.-	1/5
	WWB for Flexi DB,12Mod	—	—	—	8GB9912FWWNT	2060.-	1/5
	WWB for Flexi DB,16Mod	—	—	—	8GB9916FWWNT	2455.-	1/5
	WWB for Bus DB	—	—	—	8GB99BUSWWNT	2750.-	1/5
	WWB for Bus Plus DB	—	—	—	8GB99BPLUSWWNT	2980.-	1/5

Note:

* MRP - Maximum Retail Price

For Customized Solutions in Distribution Boards please Contact our sales Office



** Purchase MOQ for our authorised dealers is in multiples of standard packing, contact Siemens Sales Office for further details

Industrial plug & sockets

	Item Description	Incoming Slots (MW)	Outgoing Slots (MW)	Total Slots (MW)	Reference No	Unit MRP* ₹	Std. Pkg.** (Nos.)
Modular Device Boxes (MDB)							
	MDB for Flexi DB, 8Mod/Row	—	—	8	8GB9908FMDTC	2250.-	1/5
	MDB for Flexi DB, 12Mod/Row	—	—	12	8GB9912FMDTC	2555.-	1/5
	MDB for Flexi DB, 16Mod/Row	—	—	16	8GB9916FMDTC	2850.-	1/5
	MDB for Bus DB	—	—	12	8GB99BUSMBTC	3175.-	1/5
	MDB for Bus Plus DB	—	—	12	8GB99BPLUSMBTC	3455.-	1/5

	Item Description	Total Slots (MW)	Reference No	Unit MRP* ₹	Std. Pkg.** (Nos.)
Plug & Socket, IP20 with provision for MCB mounting :					
	1 Phase 20A, 1P MCB	1	8GB0501RC	1890.-	1/20
	1 Phase 20A, 2P MCB	2	8GB0501SRC	1890.-	1/20
	3 Phase 32A, 3P MCB	3	8GB0502	4015.-	1/15
	3 Phase 32A, 3P+N MCB	4	8GB0502S	4015.-	1/15
	5 Pin (3P+N+PE) 3Phase 32A MCB 3P+N MCB	8	8GB050332	6335.-	1/5
	5 Pin (3P+N+PE) 3Phase 63A MCB 3P+N MCB	8	8GB050363	16510.-	1/5

Simbox WP









	Item Description	Total Slots (MW)	Reference No	Unit MRP* ₹	Std. Pkg.** (Nos.)
Simbox WP (IP65 DBs)					
	1 Row, 4Mod	4	8GB13710	5700.-	1
	1 Row 8Mod	8	8GB13711	7240.-	1
	1 Row 12Mod	12	8GB13712	12925.-	1
	1 Row 18Mod	18	8GB13713	16740.-	1
	2 Row 2 x 12Mod	24	8GB13722	20665.-	1
	2 Row, 2 x 18Mod	36	8GB13723	29140.-	1
	3 Row, 3 x 18Mod	54	8GB13733	51240.-	1
	4 Row 4 x 18Mod	72	8GB13743	67140.-	1
Accessories for Simbox WP					
	Coupling covers, 12M		8GB20510	1865.-	1
	Coupling covers, 18M		8GB20511	2090.-	1
	Insulated N/PE terminals, 8MW		8GB20520	2905.-	1
	Insulated N/PE terminals, 12MW		8GB20521	4445.-	1
	Insulated N/PE terminals, 18MW		8GB20522	6530.-	1
Cylindrical security lock		8GB20550	5300.-	1	

Note: * MRP - Maximum Retail Price

For Customized Solutions in Distribution Boards please Contact our sales Office

** Purchase MOQ for our authorised dealers is in multiples of standard packing, contact Siemens Sales Office for further details

Betagard Distribution Boards Accessories

	Item Description	Reference No	Unit MRP* ₹	Std. Pkg.** (Nos.)
Blanking Plate				
	0.5 MW	8GB9905	15.-	25
	1 MW	8GB9901	70.-	25
	1.5 MW	8GB9902	80.-	25
Insulated Shorting Links				
Single Phase Shorting Links for Shorting 1P MCBs				
For SPN and TPN PPI DB				
	5 Leg SP Shorting Link	8GB9905LSP	220.-	10
	7 Leg SP Shorting Link	8GB9907LSP	260.-	10
	9 Leg SP Shorting Link	8GB9909LSP	305.-	10
	11 Leg SP Shorting Link	8GB9911LSP	320.-	10
	13 Leg SP Shorting Link	8GB9913LSP	425.-	10
	15 Leg SP Shorting Link	8GB9915LSP	520.-	10
	17 Leg SP Shorting Link	8GB9917LSP	545.-	10
For TPN DB				
	4 Leg SP Shorting Link	8GB9904LSP	220.-	10
	6 Leg SP Shorting Link	8GB9906LSP	260.-	10
	8 Leg SP Shorting Link	8GB9908LSP	305.-	10
	10 Leg SP Shorting Link	8GB9910LSP	320.-	10
	12 Leg SP Shorting Link	8GB9912LSP	425.-	10
	14 Leg SP Shorting Link	8GB9914LSP	520.-	10
	16 Leg SP Shorting Link	8GB9916LSP	545.-	10
Two Phase, 1 meter long for shorting 2P MCBs (suitable for maximum of 28 nos. 2MW devices)				
	Shorting link without End caps, Can be cut and used.	8GB990SLDLP	5405.-	1
	End Caps for 2 pole Shorting Links	8GB990ECLDP	90.-	10
Three Phase, 1 meter long for shorting 3P MCBs (suitable for maximum of 19 nos. 3MW devices)				
	Shorting link without Enc caps, Can be cut and used.	8GB990SLTLP	5910.-	1
	End Caps for 3 pole Shorting Links	8GB990ECLTLP	130.-	10
Three Phase + N, 1 meter long for shorting TPN MCBs (suitable for maximum of 14 nos. 4MW devices)				
	Shorting link without Enc caps, Can be cut and used.	8GB990SLTPN	6245.-	1
	End Caps for 3 pole Shorting Links	8GB990ECLTPN	165.-	10
Neutral Terminals				
Neutral Terminals For 8GB0 and 8GB31 DBs (Along with Mounting Stands)				
	5 Way Neutral Link	8GB9905NL	235.-	10
	11 Way Neutral Link	8GB9911NL	350.-	10
	13 Way Neutral Link	8GB9913NL	405.-	10
	15 Way Neutral Link	8GB9915NL	450.-	10
Neutral Terminals For 8GB32 DBs (With Terminal Shroud and Cover)				
	Neutral Terminal 5 Holes	8GB9905NPE	260.-	10
	Neutral Terminal 11 Holes	8GB9911NPE	360.-	10
	Neutral Terminal 13 Holes	8GB9913NPE	425.-	10
	Neutral Terminal 15 Holes	8GB9915NPE	475.-	10
Earth Terminals				
	5 Way Earth Link	8GB9905EL	200.-	10
	11 Way Earth Link	8GB9911EL	340.-	10
	13 Way Earth Link	8GB9913EL	360.-	10
	15 Way Earth Link	8GB9915EL	425.-	10

Note: * MRP - Maximum Retail Price

** Purchase MOQ for our authorised dealers is in multiples of standard packing, contact Siemens Sales Office for further details



5SD7 Surge Protection Devices

Safe & Reliable

Surge Protection Devices are available in the following types:

Type 1 - For incoming power supply panels, in buildings with lightning protection system. Must be accompanied by downstream SPD

Type 2 - For distribution panels located downstream of Type 1 protectors or in incoming supply panels in areas of low exposure to lightning strikes, where the building is not fitted with lightning protection system

Type 3 - Always installed downstream of Type 2 protection designed to protect sensitive equipment or equipment located more than 20m downstream of Type 2 SPD

Surge Protection Devices

For protection of equipment against Lightning and Switching surges

NEW

- Standard: IEC 61643-11 / EN 61643-11
- Type 1, Type 2 and Photovoltaic surge protection
- With Remote signaling contact
- Integrated SPD health indicator

Type 1: Lightning Surge Arresters

- Maximum continuous operating voltage U_c : 350V



Reference No.	Rated voltage	Pole	Module width	Total I_{imp} (10/350 μ s)	I_{max} (8/20 μ s)	Remote status	Unit LP* ₹
5SD74121RC	240V AC	1P+N	4	50kA	50kA	Yes	18335.-
5SD74141RC	240/415V AC	3P+N	8	100kA	50kA	Yes	35690.-

Type 2: Surge Arresters



Reference No.	Rated voltage	Pole	Module width	U_c	I_{max} (8/20 μ s)	Remote status	Unit LP* ₹
5SD74610RC	240V AC	1P	1	335V AC	20kA	No	3000.-
5SD74640RC	240/415V AC	3P+N	4	335V AC	40kA	No	8910.-

Surge Arresters for Photovoltaic application

On the DC side, over voltage protection is required for the inverters which can be ensured by using 5SD74836RC.

On the AC side, the over voltage protection can be ensured using surge arresters Type 2 (5SD7461-0RC/5SD7464-0RC)



Reference No.	Rated voltage	Pole	Module width	U_{cpv}	I_{max} (8/20 μ s)	Remote status	Unit LP* ₹
5SD74836RC	1170V DC	L+ and L-	3	1170V DC	40kA	No	5060.-

Note: Standard packing: 1 unit

*LP: List Price



Surge Protection Devices

For protection of equipment against Lightning and Switching surges

Type 1: Lightning Surge Arresters

For TN-S/ TT system

Lightning arresters, Type 1 requirement class B, U_c 350V Pluggable protective modules 4-pole, 3+1 circuit for TN-S and TT systems with remote display



Rated voltage U_N	Backup fuse rating	Protection level	Lightening impulse current $I_{mp}(10/350\mu s)$		Pole	Reference No.	Unit LP* ₹
			L-N or L-(PE), 1P/3P	N-PE			
240V AC	125A gL/gG	1.5-2.5kV	25kA	100kA	1P+N	5SD74121	Price on request
240/415V AC	125A gL/gG	1.5-2.5kV	25kA/75kA	100kA	3P+N	5SD74141	

For TN-C system

Lightning arresters, Type 1 requirement class B, U_c 350V Pluggable protective modules 3-pole, 3+0 circuit for TNC systems with remote display



Rated voltage U_N	Backup fuse rating	Protection level	Lightening impulse current $I_{mp}(10/350\mu s)$		Pole	Reference No.	Unit LP* ₹
			L-N or L-(PE), 1P/3P	N-PE			
240/415V AC	125A gL/gG	$\leq 1.5kV$	25kA/75kA	-	3P	5SD74131	61010.-

Type 2 : Surge Arresters

For TN-S/ TT system

Surge arrester Type 2 requirement class C, U_c :350V/260V (L-N/N-PE) Pluggable protective modules 4-pole, 3+1 circuit for TN-S and TT AC systems

Rated Discharge Surge Current $I_n=20kA$ SC capacity with backup fuse=25kA



Rated voltage U_N	Backup fuse rating	Protection level U_p	Rated discharge current I_n (8/20usec)		Pole	Remote signaling	Reference No.	Unit LP* ₹
			L-N or L-(PE), 1P/3P	N-PE				
240/415V	80A gL/gG	1.5-1.9kV	40kA	40kA	3P+N	No	5SD74640	Price on request
240/415V	80A gL/gG	1.5-1.9kV	40kA	40kA	3P+N	Yes	5SD74641	
240V	80A gL/gG	1.5-1.9kV	20kA	20kA	1P+N	No	5SD74220	
240V	80A gL/gG	1.5-1.9kV	20kA	20kA	1P+N	Yes	5SD74221	

For TN-C system

Surge arrester Type 2 requirement class C, U_c :350V Pluggable protective modules 3-pole, 3+0 circuit for TNC systems



Rated voltage U_N	Backup fuse rating	Protection level U_p	Maximum discharge surge current I_{max} L-N or L-(PE)N, 1P		Pole	Remote signaling	Reference No.	Unit LP* ₹
			L-N or L-(PE)N, 1P	L-N or L-(PE)N, 1P				
240/415V	80A gL/gG	$\leq 1.5kV$	40kA	40kA	3P	No	5SD74630	27815.-
240/415V	80A gL/gG	$\leq 1.5kV$	40kA	40kA	3P	Yes	5SD74631	18605.-

L - Line, N - Neutral, PE - Protective Earth

Note: Standard packing: 1 unit

* LP : List Price

Surge Protection Devices

For protection of equipment against Lightning and Switching surges

NEW

Type 3 : Surge Arresters



Rated voltage	Rated current	Protection level	Rated discharge current	Pole	Reference No.	Unit LP* ₹
24V AC 34V DC	26A	0.65kV	1kA	2P	5SD74325	12085.-
120V AC 150V DC	26A	0.95kV	3kA	2P	5SD74326	13170.-
240V AC 240V DC	26A	1.5kV	3kA	2P	5SD74326	13520.-

Surge arresters for photovoltaic application

Due to the combination of three power varistors, the overvoltage protection required for the inverters is implemented on the DC side. On the AC side, the overvoltage protection can be ensured using surge arresters type 2 (5SD7422-/5SD7424-)



5SD74836

Rated voltage U_N	Rated discharge current	Protection level U_p	Lightning Impulse current (L-N/L-(PE)N)	Max. discharge current	Pole	Remote signaling	Reference No.	Unit LP* ₹
1000V DC	15kA	$\leq 3.5kV$	$\leq 5kA$	40kA	3P	No	5SD74836	Price on request

Replacement Plug



SPD Type	Type	Connection	Reference No.	Unit LP* ₹
5SD74121	Type 1	L-N	5SD74181	21535.-
5SD74131				
5SD74141				
5SD74121	Type 2	N-PE	5SD74180	14305.-
5SD74131				
5SD74141				
5SD7463-0/1	Type 2	L-N	5SD74681	5620.-
5SD7464-0/1				
5SD7464-0/1				
5SD7422-0/1	Type 2	N-PE	5SD74880	5620.-
5SD7422-0/1				
5SD7422-0/1				
5SD7422-0/1	Type 2	L-N	5SD74281	4335.-
5SD7422-0/1				
5SD7422-0/1				
5SD7422-0/1	Type 2	N-PE	5SD74280	8210.-
5SD7422-0/1				
5SD7422-0/1				
5SD7483-6	PV	-	5SD74983	Price on request

* Also available Type 1+ Type 2 and Type 1/2 Compact SPDs for protection against overvoltages from Lightning strikes as well as by switching operations in network

Note:
Standard packing: 1 unit
* LP - List Price



SENTRON

Modular Devices

For efficient control and monitoring

- 7LF time switch - Digital and Analog timers for all applications; available in Mini, Top, Profi, Astro, Expert and Expert GPS variants
- 5TT5 insta contactors – For all control applications; also with Manual/Automatic switching indicator
- DIN mounted phase indicators, monitoring relays and measuring devices for final distribution circuits
- Twilight Switch for Automatic Street Light Control

Modular Devices

	Item Description	Rated Current I _n (A)	MW [#]	Reference No	Unit LP* ₹	Std. Pkg.** (Nos.)
Changeover switches						
Standards: IEC 60947-3/DIN EN 60947-3						
	1C/O, 230V	20	1	5TE8161	1900.-	1/10
	2C/O, 400V	20	1	5TE8162	3470.-	1/10
	Group switch, center position, 2C/O, 400V	20	1	5TE8142	4005.-	1/10
Insta Contactors						
Standards: EN 60947-4-1, EN 60947-5-1						
	2NO contacts, 230Vac	20	1	5TT58000	3020.-	1/5
	3NO+1NC contacts, 230Vac/220Vdc (1NC contact rated for 30A)	40	3	5TT58410	8260.-	1/5
	3NO+1NC contacts, 24Vac/24Vdc (1NC contact rated for 30A)	40	3	5TT58412	8295.-	1/5
	4NO contacts, 230Vac/220Vdc	40	3	5TT58400	8320.-	1/5
	4NO contacts, 24Vac/24Vdc	40	3	5TT58402	8175.-	1/5
	3NO+1NC contacts, 230Vac/220Vdc (1NC contact rated for 30A)	63	3	5TT58510	11500.-	1/5
	3NO+1NC contacts, 24Vac/24Vdc, (1NC contact rated for 30A)	63	3	5TT58512	12160.-	1/5
	4NO contacts, 230Vac/220Vdc	63	3	5TT58500	10545.-	1/5
4NO contacts, 24Vac/24Vdc	63	3	5TT58502	11115.-	1/5	
Insta Contactors Manual / Automatic with Switching Indicator						
Standards: IEC60947-4-1, IEC60947-5-1						
	2NO contacts, 230Vac	20	1	5TT58006	4020.-	1/5
	1NO+1NC contacts, 230Vac	20	1	5TT58016	6055.-	1/5
	4NO contacts, 230Vac	25	2	5TT58306	5690.-	1/5
	4NO contacts, 400Vac	40	3	5TT58406	12530.-	1/5
	4NO contacts, 400Vac	63	3	5TT58506	15880.-	1/5
Accessories						
	Control Switch with 1 Make and 1 Break Contact For AC 230V/400V For 5TT58 and 5TT50			5TT59101	3435.-	1/10





Note:

* LP - List Price # 1MW (Module Width) = 18mm

** Purchase MOQ for our authorised dealers is in multiples of standard packing, contact Siemens Sales Office for further details





Modular Devices

	Item Description	Rated Current I _n (A)	MW#	Reference No	Unit LP* ₹	Std. Pkg.** (Nos.)
Twilight switch						
	Twilight Switch with light sensor 230 V, 50/60 Hz, 1 MW, 16A			7LQ2300	Price on request	1
Voltage Relays Standards: IEC 60255, DIN VDE 0435-303						
	Voltage relay for undervoltage monitoring of 1,2,3 phases against N with phase failure detection, Switching thresholds 0.7-0.9xV, not adjustable; 2 C/O contacts, 4A, 230/400Vac	4	2	5TT3402	13250.-	1
	Voltage relay for undervoltage monitoring of 1,2,3 phases against N, short time failure detection with phase failure detection and N conductor monitoring, Switching thresholds 0.8-0.85xV, not adjustable; 2 C/O contacts, 230/400Vac	4	2	5TT3407	22065.-	1
	Voltage relay for over and undervoltage monitoring of 3 phases against N with asymmetry, reverse voltage and phase failure detection with N conductor monitoring and adj. Time delay of 0.1 to 20s, Switching thresholds: U/voltage 0.7-1.1xV, 4% hysteresis, adjustable, O/voltage 0.9-1.1xV, 4% hysteresis, adjustable; 2 C/O contacts, 230/400Vac	4	2	5TT3408	25400.-	1
RYG 3 phase indicator in 1 MW						
	3 phase indicator (all with green color cap)		1	5TE5802	3420.-	1/10
	3 phase indicator (red/yellow/green)		1	5TE5803	2910.-	1/10
	Transparent cap (1 set = 3 items, R, Y, G lens)			5TG8070	945.-	1/10
Power ON Indicator (Economy Version) 230 Vac, 1 Phase						
	Light indicators for max. cable length up to 5 m with 1 red lamp		1	5TE5800	1810.-	1/12
	Light indicators for max. cable length up to 250 m with 1 red lamp		1	5TE5804	1440.-	1/12
	Transparent cap (Red)			5TG8061	135.-	5
	Transparent cap (Green)			5TG8062	135.-	5
	Transparent cap (Yellow)			5TG8063	135.-	5
	Transparent cap (Blue)			5TG8064	135.-	5
Fuse Monitor						
	Fuse monitors with transparent caps for all low voltage fuse systems, 230Vac	4	2	5TT3170	10395.-	1

Note:

* LP - List Price # 1 MW (Module Width) = 18mm

Modular Devices

	Item Description	Rated Current I _n (A)	MW#	Reference No	Unit LP* ₹	Std. Pkg.** (Nos.)
Time Switches (Digital)						
	Mini digital, daily/weekly program, 100 hours reserve, 230Vac	16	1	7LF45015	7745.-	1
	Yearly time switch top digital 230V, 1 channel	16	2	7LF45110	9260.-	1
	Yearly time switch top digital 230V, 2 channel	16	2	7LF45120	20145.-	1
	Weekly time switch profi digital 230V, 1 channel	16	2	7LF45210	18770.-	1
	Weekly time switch profi digital 230V, 2 channel	16	2	7LF45220	24270.-	1
	Weekly time switch astro digital 230V, 1 channel	16	2	7LF45310	16780.-	1
	Weekly time switch astro digital 230V, 2 channel	16	2	7LF45320	43490.-	1
Time Switches (Mechanical) Standards: EN 60730-1						
 7LF53005	Quartz time switch Day 1 NO 230V/50-60Hz 1 MW with power reserve	16	1	7LF53011	6340.-	1
	Synchronous time switches without power reserve, for DIN rail mounting, day disk, 1CO, 230V AC	16	3	7LF53005	3500.-	1
	Quartz-clock time switches with power reserve for DIN rail mounting, day disk, 1CO, 230V AC	16	3	7LF53016	6765.-	1
	Quartz-clock time switches with power reserve for wall mounting, day disk, 1CO, 250Vac	16	—	7LF53050	10120.-	1
	Synchronous time switches without power reserve, for wall mounting, day disk, 1CO, 250Vac	16	—	7LF53010	6170.-	1
Accessories for Digital Time Switches						
	USB adapter and software			7LF49410	28540.-	1
	Data key profi, astro			7LF49411	2905.-	1

Note:

* LP - List Price

1MW (Module Width) = 18mm

** Purchase MOQ for our authorised dealers is in multiples of standard packing, contact Siemens Sales Office for further details



SIEMENS
Ingenuity for life



3VM moulded case circuit breaker

Efficient. Powerful.

- Rated current: 16A to 630A
- 1 pole[^], 2 pole[^], 3 pole & 4 pole versions
- Breaking capacity: 16kA to 55kA
- Thermal magnetic trip unit (FTFM, ATFM, AM, FM)
- Switch disconnectors
- Common Internal accessories for the entire range
- Knowledge Manager (QR Code)

3VM Moulded Case Circuit Breakers⁵



SENTRON 3VM, Thermal Magnetic Trip Unit, Fixed Thermal Fixed Magnetic (FTFM), 415VAC, 50Hz

Frame Size	Breaking Capacity @ 415VAC, 50Hz	Rated Current In (A)	3 Pole Type	Unit MRP* ₹	4 Pole Type	Unit MRP* ₹
3VM10	25kA	16	3VM10963ED320AA0	-	3VM10963ED420AA0	-
		20	3VM10203ED320AA0	-	3VM10203ED420AA0	-
		25	3VM10253ED320AA0	-	3VM10253ED420AA0	-
		32	3VM10323ED320AA0	-	3VM10323ED420AA0	-
		40	3VM10403ED320AA0	-	3VM10403ED420AA0	-
		50	3VM10503ED320AA0	-	3VM10503ED420AA0	-
		63	3VM10633ED320AA0	-	3VM10633ED420AA0	-
		80	3VM10803ED320AA0	-	3VM10803ED420AA0	-
		100	3VM10103ED320AA0	-	3VM10103ED420AA0	-
		3VM11		125	3VM11123ED320AA0	-
160	3VM11163ED320AA0			-	3VM11163ED420AA0	-

SENTRON 3VM, Thermal Magnetic Trip Unit, Adj. Thermal Fixed Magnetic (ATFM), 415VAC, 50Hz

Frame Size	Breaking Capacity @ 415VAC, 50Hz	Rated Current In (A)	3 Pole Type	Unit LP* ₹	4 Pole Type	Unit LP* ₹
3VM11	25kA	16	3VM11963EE320AA0	-	3VM11963GE420AA0	-
		20	3VM11203EE320AA0	-	3VM11203GE420AA0	-
		25	3VM11253EE320AA0	-	3VM11253GE420AA0	-
		32	3VM11323EE320AA0	-	3VM11323GE420AA0	-
		40	3VM11403EE320AA0	-	3VM11403GE420AA0	-
		50	3VM11503EE320AA0	-	3VM11503GE420AA0	-
		63	3VM11633EE320AA0	-	3VM11633GE420AA0	-
		80	3VM11803EE320AA0	-	3VM11803GE420AA0	-
		100	3VM11103EE320AA0	-	3VM11103GE420AA0	-
		125	3VM11123EE320AA0	-	3VM11123GE420AA0	-
3VM12		160	3VM11163EE320AA0	-	3VM11163GE420AA0	-
		200	3VM12204EE320AA0	-	3VM12204GE420AA0	-
3VM13		250	3VM12254EE320AA0	-	3VM12254GE420AA0	-
		320	3VM13324EE320AA0	-	3VM13324GE420AA0	-
3VM14	36kA	400	3VM13404EE320AA0	-	3VM13404GE420AA0	-
		500	3VM14504EE320AA0	-	3VM14504GE420AA0	-
		630	3VM14634EE320AA0	-	3VM14634GE420AA0	-

Internal accessories for SENTRON 3VM10/11/12/13/14 100A-630A

MLFB	Description	Unit LP* ₹
Auxiliary Switches and Alarm Switches (1 C/O)		
3VM9988-0AA12	Auxiliary Switch AUX (1 C/O)	-
3VM9988-0AB12	Trip Alarm Switch TAS (1 C/O)	-

External Accessories:

MLFB	Description	Unit LP* ₹
Rotary Handles		
3VM9117-0FK51	Door mounted Rotary Operator with 8UC drive, Standard, 3VM10/ 11	-
3VM9217-0FK51	Door mounted Rotary Operator with 8UC drive, Standard, 3VM12	-
3VM9417-0FK51	Door mounted Rotary Operator with 8UC drive, Standard, 3VM13/ 14	-

Raja+ DOL Starters[®] 3TW Direct On Line Starters



3ph, 50Hz DOL Starter in sheet steel housing, including bimetal relay with single phasing protection

Motor rating HP	kW	Relay Range A	Reference No ¹⁾	Unit MRP* ₹	Std. Pkg. (Nos.)
0.33	0.25	0.63-1	3TW72911A.64	-	1
0.75	0.55	1-1.6	3TW72911A.66	-	1
1	0.75	1.6-2.5	3TW72911A.68	-	1
1.5	1.1	2-3	3TW72911A.69	-	1
2	1.5	3.2-5	3TW72911A.71	-	1
3	2.2	4-6.3	3TW72911A.72	-	1
5	3.7	6.3-10	3TW72911A.74	-	1
-	-	8-12.5	3TW72911A.75	-	1
7.5	5.5	10-16	3TW72911A.77	-	1
10	7.5	12.5-20	3TW72911A.78	-	1

¹⁾ Enter code for coil voltage, 50Hz (B for 200-400V, W for 415V)

[®] Kindly refer latest Motor Control Products Price List for prices

* MRP - Maximum Retail Price LP - List Price

⁵ Kindly refer latest LV Power Distribution Products Price List for prices

Switch disconnecter fuse® Superswitch 3KL8 in open execution 3PN

Switch Disconnector fuse: 3KL8 for power distribution (in Open Execution 3PN)^(

	Rated current Ie @ 690V AC 50Hz	SDF suitable for DIN type HRC Fuses	SDF suitable for BS type HRC Fuses	SDF suitable for cylindrical type HRC Fuses	Std. pkg. (nos.)
	20A	3KL8111-5TA00	3KL8111-5TJ00	3KL8111-5TC00	1
	32A	3KL8121-5TA00	3KL8121-5TJ00	3KL8121-5TC00	1
	63A	3KL8151-5TA00	3KL8151-5TJ00	3KL8151-5TC00	1
	100A	3KL8171-5TA00	-	-	1
	100A	3KL8211-5TA00	3KL8211-5TJ00	-	1
	125A	3KL8221-5TA00	3KL8221-5TJ00	-	1
	160A	3KL8231-5TA00	3KL8231-5TJ00	-	1
	200A	3KL8311-5UA00	3KL8311-5UJ00	-	1
	250A	3KL8321-5UA00	3KL8321-5UJ00	-	1
	315A	3KL8331-5UA00	3KL8331-5UJ00	-	1
	400A	3KL8341-5UA00	3KL8341-5UJ00	-	1
	500A	3KL8411-5UA00	3KL8411-5UJ00	-	1
	630A	3KL8421-5UA00	3KL8421-5UJ00	-	1
	800A	3KL8431-5UA00	3KL8431-5UJ00	-	1

^ 3PN is 3 Pole with neutral link

Selection table for SS Housing for 3KL8



	Rated current Ie (A)	Reference No	Unit MRP* ₹	Std. Pkg. (Nos.)
	3KL81 (20A - 63A)	3KX8235-4AC	-	1
	3KL82 (100A - 160A)	3KX8235-4AC	-	1
	3KL83 (200A - 400A)	3KX8345-4AC	-	1
	3KL84 (500A - 800A)	3KX8435-4AC	-	1

Rated current Ie (A)	Gland box Reference No.	Unit MRP* ₹	Gland Plate Reference No.	Unit MRP* ₹	Std Pkg. (Nos.)
3KL81(20A-63A)	3KX8235-4DC	-	3KX8235-4GC	-	1
3KL82(100A-160A)	3KX8235-4DC	-	3KX8235-4GC	-	1
3KL83(200A-400A)	3KX8345-4DC	-	3KX8345-4GC	-	1
3KL84(500A-800A)	3KX8435-4DC	-	3KX8435-4GC	-	1

LV HRC Fuses®

DIN Type Fuse



Rated voltage: 500 V AC

	Size	Rated current A	Reference No	Unit MRP* ₹	Std. Pkg. (Nos.)
	000	2	3NA7 802-ORC	-	1/6
		4	3NA7 804-ORC	-	
		6	3NA7 801-ORC	-	
		10	3NA7 803-ORC	-	
		16	3NA7 805-ORC	-	
		20	3NA7 807-ORC	-	
		25	3NA7 810-ORC	-	
		32	3NA7 812-ORC	-	
		40	3NA7 817-ORC	-	
		50	3NA7 820-ORC	-	
		63	3NA7 822-ORC	-	
		80	3NA7 824-ORC	-	
		100	3NA7 830-ORC	-	
	00	125	3NA7 832-ORC	-	
		160	3NA7 836-ORC	-	
	1	50	3NA7 120-ORC	-	1/3
		63	3NA7 122-ORC	-	
		80	3NA7 124-ORC	-	
		100	3NA7 130-ORC	-	
		125	3NA7 132-ORC	-	
		160	3NA7 136-ORC	-	
		200	3NA7 140-ORC	-	
		224	3NA7 142-ORC	-	
		250	3NA7 144-ORC	-	

400 & 800A fuses - Rated voltage at 415 V AC

Note: * MRP - Maximum Retail Price

@ Kindly refer latest Power Distribution Products Price List for prices



	Size	Rated current A	Reference No	Unit MRP* ₹	Std. Pkg. (Nos.)
	2	200	3NA7 240-ORC	-	1/3
		250	3NA7 244-ORC	-	
		315	3NA7 252-ORC	-	
		400#	3NA7 260-ORC	-	
	3	315	3NA3 352-ORC	-	1/3
		400	3NA3 360-ORC	-	
		500	3NA3 365-ORC	-	
		630	3NA3 372-ORC	-	
		800#	3NA3 375-4RC	-	

BS Fuses

	Type	Rated current A	Reference No	Unit MRP* ₹	Std. Pkg. (Nos.)
	Offset Tag	2	3NW TIA2	-	20
		4	3NW TIA4	-	
		6	3NW TIA6	-	
		10	3NW TIA10	-	
		16	3NW TIA16	-	
		20	3NW TIA20	-	
		25	3NW TIA25	-	
		32	3NW TIA32	-	
		40	3NW TIS40	-	
		50	3NW TIS50	-	
		63	3NW TIS63	-	

Available till stocks last

Betagard Distribution Boards 8GB31

	Item Description	Incoming Slots (MW)	Outgoing Slots (MW)	Total Slots (MW)	Reference No	Unit MRP* ₹	Std. Pkg.** (Nos.)
BetaMulti (DBs for power & communication), IP42 :							
	12 way SPN, built-in	2	12	14	8GB31315RC	Price on request	1
	4 Way TPN, Built-in	8	12	20	8GB31320RC		1
	6 way TPN, built-in	8	18	26	8GB31321RC		1
	8 Way TPN, Built-in	8	24	32	8GB31322RC		1
Beta CO (DBs with provision for phase changeover switches), IP42 :							
	4 way, with provision	8	12	20	8GB31840RC	Price on request	1
	6 way, with provision	8	18	26	8GB31841RC		1
	8 way, with provision	8	24	32	8GB31842RC		1
	12 way, with provision	8	36	44	8GB31844RC		1

Available till stocks last

Discontinued Products

Betagard Circuit Breakers 5SY7, with D Characteristics

Reference No.	Reference No.	Reference No.	Reference No.
5SY71058CC	5SY72058CC	5SY73058CC	5SY74058CC
5SY71018CC	5SY72018CC	5SY73018CC	5SY74018CC
5SY71028CC	5SY72028CC	5SY73028CC	5SY74028CC
5SY71038CC	5SY72038CC	5SY73038CC	5SY74038CC
5SY71048CC	5SY72048CC	5SY73048CC	5SY74048CC
5SY71068CC	5SY72068CC	5SY73068CC	5SY74068CC
5SY71088CC	5SY72088CC	5SY73088CC	5SY74088CC
5SY71108CC	5SY72108CC	5SY73108CC	5SY74108CC
5SY71138CC	5SY72138CC	5SY73138CC	5SY74138CC
5SY71168CC	5SY72168CC	5SY73168CC	5SY74168CC
5SY71208CC	5SY72208CC	5SY73208CC	5SY74208CC
5SY71258CC	5SY72258CC	5SY73258CC	5SY74258CC
5SY71328CC	5SY72328CC	5SY73328CC	5SY74328CC
5SY71408CC	5SY72408CC	5SY73408CC	5SY74408CC
5SY71508CC	5SY72508CC	5SY73508CC	5SY74508CC
5SY71638CC	5SY72638CC	5SY73638CC	5SY74638CC

Betagard Circuit Breakers 5SY5, DC with C Characteristics

Reference No.	Reference No.
5SY51057CC	5SY52057CC
5SY51017CC	5SY52017CC
5SY51027CC	5SY52027CC
5SY51037CC	5SY52037CC
5SY51047CC	5SY52047CC
5SY51067CC	5SY52067CC
5SY51087CC	5SY52087CC
5SY51107CC	5SY52107CC
5SY51137CC	5SY52137CC
5SY51167CC	5SY52167CC
5SY51207CC	5SY52207CC
5SY51257CC	5SY52257CC
5SY51327CC	5SY52327CC
5SY51407CC	5SY52407CC
5SY51507CC	5SY52507CC
5SY51637CC	5SY52637CC

Betagard Distribution Boards MB DBs

Reference No.	Reference No.
8GB31810RC01	8GB31810RC03
8GB31811RC01	8GB31811RC03
8GB31812RC01	8GB31812RC03
8GB31813RC01	8GB31813RC03
8GB31814RC01	8GB31814RC03
8GB31815RC01	8GB31815RC03
8GB31810RC02	
8GB31811RC02	
8GB31812RC02	
8GB31813RC02	
8GB31814RC02	
8GB31815RC02	

Terms and Conditions

Maximum Retail Price (MRP) / List Price (LP) is subject to revision without prior notice.

The company reserves the right to supply goods at its works or godown at its discretion.

The minimum order size for non-stock items (items not marked with ■) is 50 Nos. for each item or ₹ 50,000/- per item.

Export control regulation - retention clause: The fulfillment of the agreement on Siemens part is subject to the provision that this shall not be prevented by implements on the grounds of national and international legal requirements, in particular export control provision.

Stock items

The normal stock items (indicated by ■) are subject to change without prior notice.

Note

- This supercedes all previous Price Lists.
- List Prices (LPs) mentioned are exclusive of all taxes.
- Maximum Retail Prices (MRPs) mentioned in the publication are maximum recommended selling prices.
- Invoice amount not to exceed MRP
- Invoice amount = MRP (less) applicable discount + applicable GST %
- For receiving material in factory sealed packing, we request you to order in multiples of the indicated standard packing quantity.

Ask your nearest Siemens partners to include you in our mailing list.

Always make your purchases only from our authorised dealers. Details available with our sales office/territory managers.

SIEMENS

Ingenuity for life



5SL Miniature Circuit Breaker - K & Z Curve

"K" Characteristic Trip Curve:

MCB trips instantaneously when the current flowing through it reaches between 10 to 14 times the rated current.

Suitable for inductive and motor loads with high inrush currents; etc

"Z" Characteristic Trip Curve:

MCB trips when the current flowing through it reaches between 2 to 3 times the rated current, highly sensitive to short circuit current

Suitable for the protection of highly sensitive devices such as semiconductor devices,

- In compliance with standards IEC 60947-2
- Range available from 2A – 63A
- Comprehensive features & accessories in line with 5SL MCB
- For protection in Industrial, Infrastructure, Process Automation, Commercial applications



7KT PAC1200

Multichannel current measuring system
For flexible multichannel monitoring in final
distribution

Current Sensors

- Versions: 40 A, 63 A

Sensor Bar

- Versions available for 3, 6, 9, 12

Data Manager

- Connection of up to 96 sensors (40A/63A)
- DIN rail installation (4MW)

Communication/ Software:

- Modbus TCP/ IP
- Simple system onfiguration via web server
- Easy access to energy data with mobile app (iOS/Android)

*For more details, contact nearest Siemens Sales Office



- Modbus TCP/IP communication
- Simple configuration of system via powerconfig v3.6 and web server
- Visualization of consumption via Webserver and Mobile App (Android/iOS)

- Flexible sensor bars and current sensors to record up to 96 circuits in one system
- Current sensors simply plug onto the sensor bars, eliminating extensive wiring

fast

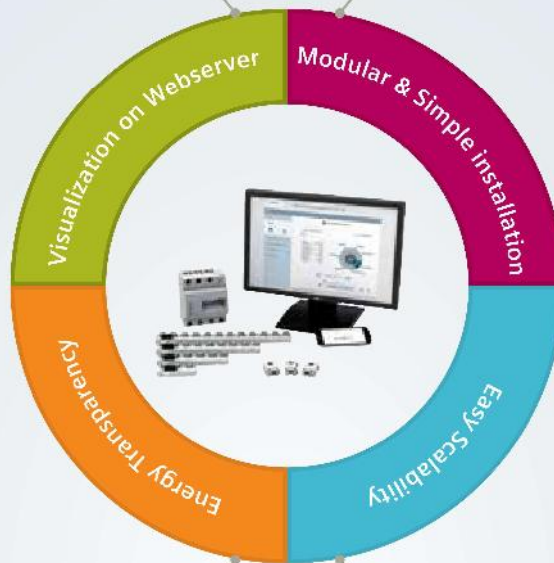

plug
and
play

- Targeted detection of power guzzlers
- Simultaneous display of power consumption and costs
- Ensures optimal power monitoring

- Easy to Upgrade
- Scale up the system without any interruption or cumbersome wiring



Easy



Transparent



Cost-efficient



Relevant Standards

Title	IS	IEC	Products							
			MCB		RCCB		RCBO	DB	AFDD	SPD
			5SL4/6/7	5SL5	5SV	5SM	5SU1	8GB	5SM6	5SD7
Electric Installations – MCBs for Building Installations and Similar Purposes Part 1: MCBs for AC Systems	IS 60898-1	IEC 60898-1	✓	–	–	–	–	–	–	–
Low-voltage switchgear and controlgear Part 2: Circuit-breakers	IS 60947-2	IEC 60947-2	–	✓	–	–	–	–	–	–
Residual Current Operated Circuit-Breakers for Household and Similar Uses, Part 1: Circuit-Breakers Without Integral Overcurrent Protection (RCCBs)	IS 12640-1	IEC 61008-1	–	–	✓	✓	–	–	–	–
Residual Current Operated Circuit-Breaking for Household and Similar Uses, Part 2: Circuit-Breakers with Integral Overcurrent Protection (RCBOs)	IS 12640-2	IEC 61009-1	–	–	–	–	✓	–	–	–
General requirements for arc fault detection devices	–	IEC 62606	–	–	–	–	–	–	✓	–
Low-voltage switchgear and controlgear assemblies, Part 2: Power switchgear and controlgear assemblies	–	IEC 61439-1/3	–	–	–	–	–	✓	–	–
Surge protective devices connected to low-voltage power systems	–	IEC 61643-11	–	–	–	–	–	–	–	✓



Degree of Protection

First digit: Protection against solid foreign objects		Second digit: Protection against ingress of water	
	0 No protection		0 No protection
	1 Protected against solid objects up to 50mm (e.g. hand)		1 Protection against vertically falling drops of water (e.g. condensation)
	2 Protected against solid objects up to 12mm diameter (e.g. finger)		2 Protection against direct sprays of water up to 15 degrees from vertical
	3 Protected against solid objects up to 2.5mm diameter (e.g. screwdriver)		3 Protection against direct sprays of water up to 60 degrees from vertical
	4 Protected against solid objects up to 1mm diameter (e.g. wire)		4 Protection against water sprayed from all directions, limited ingress permitted
	5 Protected against dust: limited ingress permitted, no harmful deposit.		5 Protected against low-pressure jets of water from all directions, limited ingress permitted
	6 Totally protected against dust		6 Protected against strong jets of water from all directions, limited ingress permitted (e.g. water from heavy seas on a ship's deck)
			7 Protected against the effect of temporary immersion (30 min) between 15cm and 1m
			8 Protected against long period of immersion under pressure
			9 Protected against high pressure, high temperature jets of water from multiple directions



Installation Guideline for RCCB

RCCB suitability for various distribution networks.

Betagard RCCBs can be used in all 3 distribution network types viz. TN, TT & an IT network system. 4 pole RCCBs can also be used in 3 pole supply networks by adhering to installation guidelines. In this case, connection must be at terminals 1, 3 and 5 and 2, 4 and 6.

The function of the test equipment is only ensured if a jumper is fitted between terminals 3 and N.

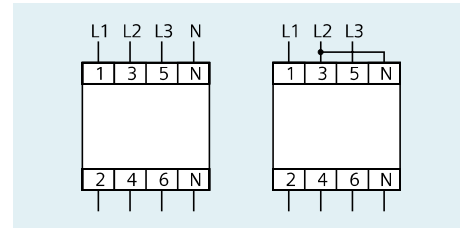

Types and waveform

					6 mA	10 mA		
Type AC		■	-	-	-	-	-	-
Type A		■	■	■	■	-	-	-
Type F		■	■	■	■	■	■	-
Type B		■	■	■	■	■	■	■
Type B+		■	■	■	■	■	■	■

Version

SIGRES	with active condensation protection for use in severe ambient conditions
[G] / [K]	super-resistant, 10 ms short-term delayed devices with increased immunity to false triggering due to transient disruptions
[S]	as an upstream group switch for selective shutdown against downstream RCCBs



Installation locations for Surge Protection Devices (SPDs)

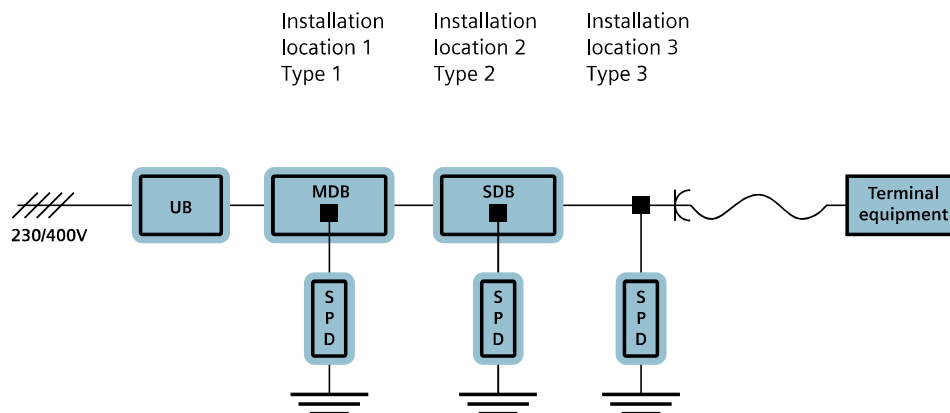

UB: Utility Box

MDB: Main distribution board

SDB: Sub Distribution board

Installation location 1 must be as close as possible to the supply point for the electrical system, so that the downstream installations are protected. The SPDs at installation locations 2 and 3 shall not be used without SPDs at installation location 1, and they must be coordinated with these SPDs (i.e. SPDs all from the same manufacturer).

One point contact for your service needs

The comprehensive range of services from Siemens is sure to cover the needs of the most varied users. We offer structured

services, designed to give you valuable support in every phase during the lifecycle of your Final Distribution Products.

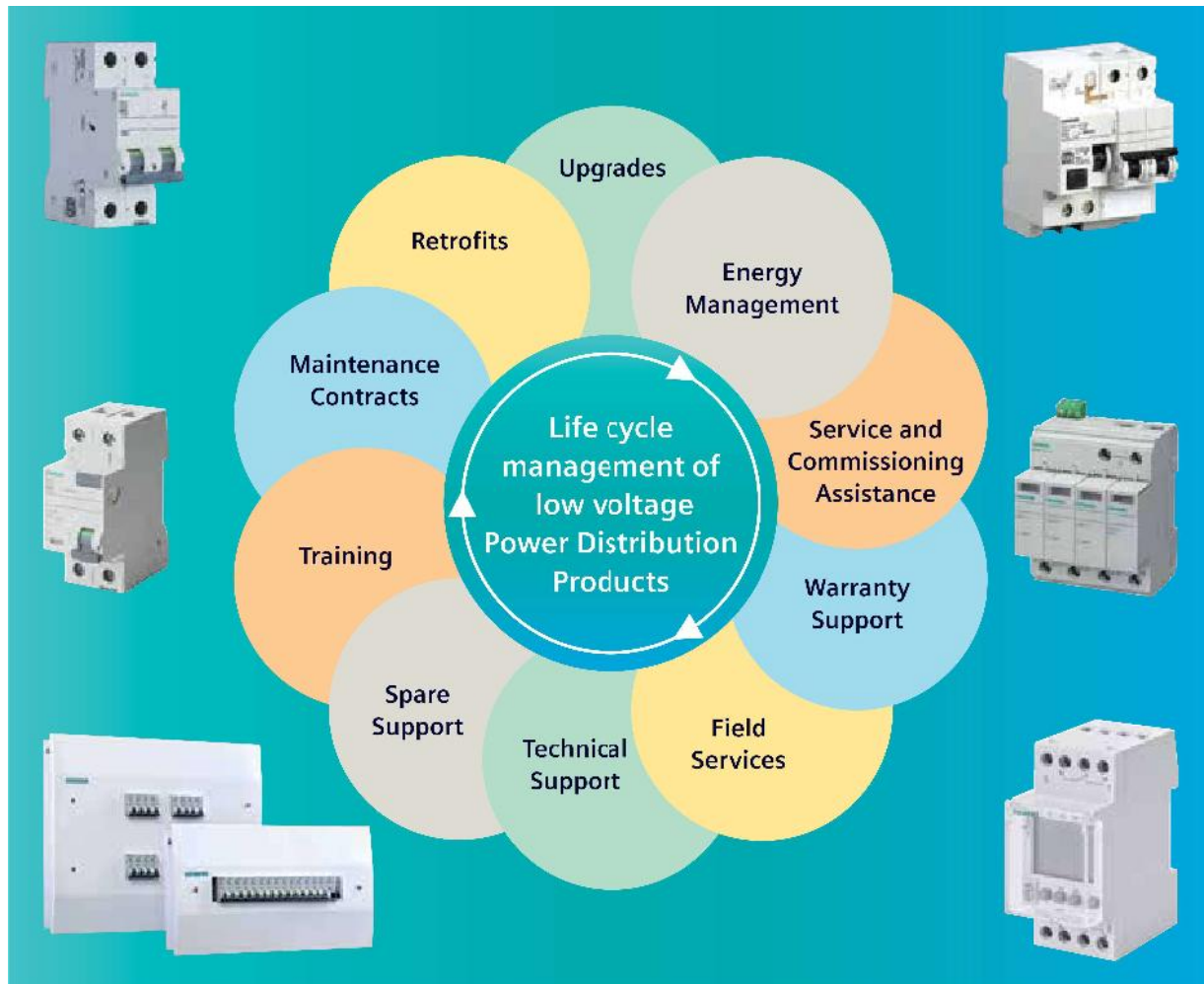

Please contact us for more details

CUSTOMER CARE

Toll Free No: 1800220987 / 18002090987 • E-mail: ics.india@siemens.com

Customer care

One stop support for all service needs:

- Breakdown service
- Annual maintenance contracts
- Retrofit solutions
- Spares

For more details please contact:

Customer care desk

Siemens Limited

R&D Technology Centre

Kalwa Works, Thane Belapur Road, Thane - 400 601

Toll free No.: 1800 209 0987 (MTNL/BSNL/Major Mobile operator lines), 1800 220 987 (BSNL/MTNL)

Tel.: 022-27600150 • Fax: 022-33265381

<http://support.automation.siemens.com/in>

Your partners

Sales offices:

Ahmedabad
Mobile: +91 9167934326
E-mail: dhan.karburkar@siemens.com

Barda
Mobile: +91 9525001779
E-mail: chandranak.keshran@siemens.com

Bengaluru
1st Floor, Iyath Mahal, No. 49, St. Marks Rd, Bengaluru - 560 001
☎: +91 80 33422000
Fax: +91 80 33424131

Bhubaneswar
Mobile: +91 7894436373
E-mail: sommath.manna@siemens.com

Chandigarh
Mobile: +91 9888484066
E-mail: padam.sharma@siemens.com

Chennai
4th Floor, I. IA Mount Central
Seethakathi Business Centre, Mount Road
Chennai - 600006
☎: +91 44 20474000
Fax: +91 44 20474080

Coimbatore
Mobile: +91 9849001842
E-mail: pramod.krishna@siemens.com

Gurgaon
Plot No. 78, Tower - B
Jagdish Industries Building (III)
Opposite SBI Academy, Sector-18
Gurgaon - 122015
☎: +91 124 2842000, 3810200

Hyderabad
Mobile: +91 9849111875
E-mail: purnavikran@siemens.com

Jaipur
Mobile: +91 9815502480
E-mail: rohit.jaggga@siemens.com

Jamshedpur
Mobile: +91 8294052647
E-mail: shymal.bhattacharya@siemens.com

Kolkata
3rd Floor, 43, Shanti Pall
Bachibari Bypass Connector
Kolkata - 700042, India
☎: +91 33 30939000
Fax: +91 33 30939010

Lucknow
Mobile: +91 9619866025
E-mail: jain.vikas@siemens.com

Mumbai
Business Centre 1, Kalwa Works
Ithane Belapur Road
Thane - 400 601
☎: +91 22 39663000
Fax: +91 22 39663271

Nagpur
Mobile: +91 9930182128
E-mail: muzaffer.sayed@siemens.com

Pune
Tower C, Parichitli Business Park
Survey No. 20, (Ialewad)
Pune - 411045
☎: +91 20 30466000
Fax: +91 20 30466006

Vizag
Mobile: +91 9701354777
E-mail: vijaykiran.meduri@siemens.com

Territory managers:

Aggra
Flat No. 303, Dwarka Apartment
Near Honourable Mandir Crossing
Bhagirathi Road, Khandari
Aggra - 282002
Mobile: +91 7800060310
E-mail: lkhari.nayana@siemens.com

Aurangabad
Flat No. 81/103, Marjette Pride Primu
Maharajba Ashram Chowk
Beed By-Pass, Aurangabad - 531005
Mobile: +91 8889911401
E-mail: bhadauria.ami@siemens.com

Gorakhpur
H.No. 721/17, Sri Ram Nagar Colony
Near Aluminium Factory
Beside IBI Memorial School, Itasarpur
Gorakhpur - 273004
Mobile: +91 9802011478
E-mail: singh.aman@siemens.com

Guwahati Assam
Shilvaya Housing Society, Flat No. B-3A
Biyane, L. Jyotima Nagar, Adlaoni, Pandu
Guwahati - 781012, Assam
Mobile: +91 9864110681
E-mail: biblab.date@siemens.com

Kharagpur
Plot No. 3031, 2nd Floor
Mouza: Basudoypur, PO: Khajanchak
Manjusree More, District: Purba Medinipur
Pin: 721602
Mobile: +91 9951384193
E-mail: mitra.sayanika@siemens.com

Khopoli
Flat No. 12, Building No. 1
Shri Swami Samarth Krupa Nagar CHS Ltd
Near Lisha Nagar, Mogalwadi Road, Khopoli
Tal. Khalapur, Dist. Raigad - 410203
Mobile: +91 9867748975
E-mail: deshpande.sachin@siemens.com

Naidupeta
5/94, 1 Floor, B Block, M.A.Nagar
Chennai - 600052
(Near Palanalur Govt School)
Mobile: +91 9840255185
E-mail: n.pradeep@siemens.com

Nashik
Flat No. 402, 'D' Wing, Hari Shrushti
Near Jogging Track, Opposite WNS
Indira Nagar, Nashik - 422009
Mobile: +91 9892792275
E-mail: dhananjay.thorat@siemens.com

Neemrana
F-11, Anantraj Apartments, Plot No. 236
Japanese Zone, Neemrana, Awar
Rajasthan - 301705, India
Mobile: +91 9650481919
E-mail: deepak.benwal@siemens.com

Rudrapur
Shanti Vihar Colony, Chacarpur Road
Opposite Dr. Pandey Hospital
Rudrapur - 263154
Distt. Udham Singh Nagar, Uttarakhand
Mobile: +91 9839174578
E-mail: glibit.pandey@siemens.com

Salem
Rajagangnam, Lumbini Illam, No. 20
Palarajappa Nagar, Hosurhampalli
Salem - 636007
Mobile: +91 9952889893
E-mail: b.saravanan@siemens.com

Siliguri
147 Lala Lajpat Rai Road, Haider Para
Siliguri - 734001, West Bengal
Mobile: +91 7278823600
E-mail: abhishek.kar@siemens.com

Belgaum
Anugrahi Bungalow No. 2, Plot No. 7
C/S No. 3109, H/S No. 5/2/1, Cross No. 7
Near Shanbag 7 Bhandari School
Bhagyai Nagar, Anjo
Belgavi, Karnataka - 590006
Mobile: +91 9740277991
Tel: +91 0831 2495156
E-mail: anand.gavdes@siemens.com

Belgaum
Flat No. 201, 2nd Floor
Harimani Apartment, 1st Cross
Bhagyai Nagar, Anjo Extension, Belgavi
Karnataka - 590006
Mobile: +91 8105920666
E-mail: sidou.menegoud@siemens.com

Haridwar
110, Lotus Towers
Opp. Ansal Courtyard, Modipuram
Meerut - 250001, Uttar Pradesh
Mobile: +91 9899384222
E-mail: umesh.sharma@siemens.com

Hospet
Mallin's, Door No. 1288, 8th Ward
Near Markandeya School
M. R. Prakash Nagar, Hospet - 583201
Distt. Bellary, Karnataka
Mobile: +91 9945859004
E-mail: nagarajrk@siemens.com

Guwahati Assam
Mobile: +91 9051015666
E-mail: amamath.karmakar@siemens.com

Kolhapur
RS No. 84-1, Pinar Prasad, 11 No. A-35
New Palace Road, Kolhapur - 416006
Mobile: +91 9930836839
E-mail: vijay.todkar@siemens.com

Kota
Flat No. 602, Mahalaxmi Enclave, Block - B4
Itanar Road, Kota, Rajasthan - 324001
Mobile: +91 9771411108
E-mail: vikash.prasad@siemens.com

Patna
A-33, 5th Floor, Krishna Apartment
Boring Road, Patna - 800001
Mobile: +91 9641542489
E-mail: rajendra.mitra@siemens.com

Pondicherry
R.A.M Paradise, III Floor, No. 4, 2nd Cross
Kamban Nagar, Recidarpalayam
Puducherry - 605010
Mobile: +91 9176819374
E-mail: gopalakrishnan.shanmugam@siemens.com

Sonepat
H.No. 1103, 1st Floor, Sector 14, Sonepat
Haryana - 131001
Mobile: +91 9855526122
E-mail: kumar.aman.sh@siemens.com

Sriperumbudur
Villa No. 97, Casa Grande I uttura
Chennai, Tamil Nadu
Mobile: +91 9791045280
E-mail: mun.garaj.s@siemens.com

Bharuch
Gold B, 804, Sureshdra Residency
Opp. Zadeshwar Bus Stop
Zadeshwar Road, Bharuch - 392011
Mobile: +91 94299037805
E-mail: kalpesh.kumar.dar@siemens.com

Bhilai
Flat No. 38/E1 Block, Chouhan Green Valley
Juwani, Bhilai (C.C.) - 490020
Mobile: +91 7869922211
E-mail: bravin.deshbhara@siemens.com

Hosur
Plot No. 72, Vishnu Anand Galaxy
Chittanapally Nalur Village
Hosur - 635709
Mobile: +91 8917200266
E-mail: dinash.rajagan@siemens.com

Hubli
Plot No. 72, Hubliadi Building
Near KLE School, Marjatta Nagar
Geel Road, Hubli - 30, Karnataka
Mobile: +91 9945961052
E-mail: dhan.karburkar@siemens.com

Ludhiana
H.No. 728, 2nd Floor, Sector 33
Urbanislot, Chandigarh Road
Ludhiana - 141007, Punjab
Mobile: +91 9872131762
E-mail: gurvirinder.singh@siemens.com

Ludhiana
H.No. 1225, St. No. 3/1
Sardar Nagar, Rahon Road
Near Gurudwara Mata Bhagwanti
Ludhiana - 141007, Punjab
Mobile: +91 9872410990
E-mail: ravinder.pal@siemens.com

Rajpur
103 Emerald, Green Meadows, Darda Seoni
Mewar, Rajpur, Chaitigarh - 492007
Mobile: +91 9711007466
E-mail: vijay.natal@siemens.com

Raipur
Mobile: +91 9049 49199
E-mail: shridhar.gulkam@siemens.com

Rajahmundry
IVY Grand Apartment, Narasanna Nagar
Door No. 66-7-21A, Rajiv Gandhi Street
Near Karanam Gari Junction
Kakinada - 533004
Mobile: +91 9789869754
E-mail: laxmikanta.balla@siemens.com

Surat
E-203, Legend Harmony
Opp. Swasthi Vilas, Pal
Surat - 395009
Mobile: +91 9879110276
E-mail: rahul.gangrade@siemens.com

Thrissur
Plot No. 12, Charakkeran House
Unthi Nagar, Kuzhichira P.O, Thrissur
Kerala - 680006
Mobile: +91 9847957839
E-mail: nobin.babu@siemens.com

Bhopal
A-111 Shekhura, Bhopal, MP - 462016
Mobile: +91 9823011883
E-mail: vivek.l.saxena@siemens.com

Bolpur
E-103, Sai Jaypee Apartments
Yashwant Shreehti, Bolpur (West) - 400901
Mobile: +91 9819231892
E-mail: oshashi.biswas@siemens.com

Indore
Flat No. 702, Second Floor
88 N. Savinay Apartment
Dhanvantri Nagar, Rajendra Nagar
Main Road, Indore - 452012 (M. P.)
Mobile: +91 9029207888
E-mail: gurishankar.karira@siemens.com

Indore
78, Anand Nagar, Chitwad Road
Indore - 452001 (MP)
Mobile: +91 9873333024
E-mail: brajesh.athar@siemens.com

Madurai
Anirudh Block, F Top 3
Vasudhara Apartment
84, IWK Main Road, Andalapuram
Madurai - 625 003, Tamil Nadu
Mobile: +91 9894617776
E-mail: sheorasasamu@siemens.com

Mangalore
Flat No. 303, Devi Durga Residency
Near Dominican Church, Ashok Nagar Road
Unwe Store, Mangalore - 575006
Mobile: +91 9866488166
E-mail: laxmikanta.k@siemens.com

Rajkot
Pitrukupa Street No. 5, Royal Park Society
University Road, Near Indira Circle
Rajkot - 360005
Mobile: +91 8088812037
E-mail: harsh.trivedi@siemens.com

Ranchi
Raj Enclave, Flat No. 204, 2nd Floor,
Kaju Bagan (Near DAV Hehal Jr. Section)
Piska More, P.S. Sukhconagar
Ranchi - 834005
Mobile: +91 9674011440
E-mail: sarkar.saika@siemens.com

Trichy
Flat No. 102, 'B' Block, 2nd Floor
Vignesh Empire Apartments, Sala Road
Weraipur, Trichy - 620003
Mobile: +91 9056025127
E-mail: ponnilaxan.p@siemens.com

Udaipur
A-39, 1st Floor, New Ahinsapuri, Latehpura
Udaipur, Rajasthan - 313004, India
Mobile: +91 8696222212
E-mail: rohit.nadani@siemens.com

Cochin
Jemer Symphony, 33/2317, 5th Floor
Chalikkavattom, Potturuni North
Vyttila, Kochi - 682019
Mobile: +91 8696117755
E-mail: stiyam@siemens.com

Jalandhar
House No. 548, 11 Urban I state
Phase 1, Jamalpur, Chandigarh Road
Ludhiana - 141003, Punjab
Mobile: +91 9876047929
E-mail: sunil.singla@siemens.com

Maraimalainagar
No. 11, Ambedkar Street, SRS Buildings
Upstare Road, Dental Clinic, Pothan
Chennai - 602023
Mobile: +91 9840392926
E-mail: shanmuga.v@siemens.com

Meerut
110, Lotus Towers
Opp. Ansal Courtyard, Modipuram
Meerut - 250001, Uttar Pradesh
Mobile: +91 9889386222
E-mail: umesh.pandey@siemens.com

Vapi
Flat No. 302, 3rd Floor, Samranya IV
Royal Residency, Good Vihar Township
Charwad Road, Taluka - Pardi, Dist. Valsad
Vapi - 396195
Mobile: +91 9825167957
E-mail: rohit.nadani@siemens.com

Durgapur
6/15, Bengal Amcuya
(Near Durgapur Cinema Hall)
CH Centre, Durgapur - 713216, West Bengal
Mobile: +91 9830317456
E-mail: harsh.chincholkar@siemens.com

Gandhidham
Plot No. 453, DC-5, Adipur
Gandhidham - 470205
Mobile: +91 9252005162
E-mail: maullikumar.patel@siemens.com

Jammu
Plot No. 592/3, 2nd Floor
Bhawani Vihar Extension, Trikuta Nagar
Jammu - 180020
Mobile: +91 9874084776
E-mail: sharma.nikhil@siemens.com

Jodhpur
A-240, 1st Floor, Shastri Nagar, Jodhpur
Rajasthan - 342003, India
Mobile: +91 9929110993
E-mail: rajendra.kabra@siemens.com

Mehsana
Co R. K. Enterprise
Tirupati Complex, 2nd Floor
Rachanpura Char Rasta, Mehsana
Gujarat - 384002, India
Mobile: +91 9909904993
E-mail: piyush.mehes@siemens.com

Mysore
No 980, 4th Cross, 6th Main
Bannimantap B layout, SS Nagar
Mysore - 570015
Mobile: +91 9611311645
E-mail: rashid.syed@siemens.com

Renukoot
Vijay Gupta Bhuvan
Swami Vivekanand Colony, Murdhawa
Renukoot - 231217, Distt Sonbhadra
Uttar Pradesh
Mobile: +91 9984500021
E-mail: kumardeepak@siemens.com

Rourkela
C/6, Galoor Colony, Ground Floor
Near LIC Office, Udli Nagar
Rourkela - 769012, Odisha
Mobile: +91 9861056581
E-mail: ashirbad.das@siemens.com

Vijayawada
Sarada Nilayam
D.No. 21 5 44, 2nd Floor, Front Porchion
Vanapallewani Street, Opo RCM Church
Mithya Ampu, Vijayawada - 520011
Mobile: +91 9642351144
E-mail: venkateswar.d@siemens.com

Siemens Limited
Smart Infrastructure
Electrical Products
R&D Technology Centre
Thane Belapur Road
Airoli Node, Navi Mumbai - 400708
For more information contact toll free 1800 209 1800
E-mail: lvsgr-mktg.india@siemens.com
www.siemens.com.in

Order No.: 111389505
SI-EP-CG-DIPL-01 2021
(This replaces SI CP DI PL CC25022020
dated 01 March 2020)

Customer Care Toll free no. 1800 209 0987
Email: ics.india@siemens.com

Product upgradation is a continuous process. Hence, data in this pricelist is subject to change without prior notice. For the latest information, please get in touch with our Sales Offices.